

















Power-PRO™ 2 Cot



















Operations/Maintenance Manual











REF	650700000000
REF	650700080301
REF	650700450301
REF	650705550001
REF	650705550002
REF	650705550003

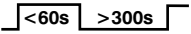

Symbols

	Refer to instruction manual/booklet
	Consult instructions for use
	General warning
	Caution
	Warning; crushing of hands
	Warning; non-ionizing radiation
	No pushing
	China RoHS without declarable substances
	China RoHS with declarable substances
	CE mark
	UK Conformity Assessment mark
	Importer
	Unique device identifier
	Authorized representative in the European Community
	Authorized representative in Switzerland
	European medical device
	Catalogue number

	Lot (batch) code
	Serial number
	For US Patents see www.stryker.com/patents
	Manufacturer
	Date of manufacture
	Mass of equipment with safe working load
	Safe working load
	Type BF applied part
	Medical Equipment Classified by Underwriters Laboratories Inc. With Respect to Electric Shock, Fire, and Mechanical Hazards Only in Accordance with ANSI/AAMI ES60601-1:2012 and CAN/CSA-C22.2 No. 60601-1:14.
	Direct current
	Alternating current
	Class II electrical equipment: equipment in which protection against electric shock does not rely on basic insulation only, but in which additional safety precautions such as double insulation or reinforced insulation are provided, there being no provision for protective earthing or reliance upon installation conditions.
	Dangerous voltage
	Extend
	Retract
IP36	Ingress protection rating
	In accordance with European Directive 2012/19/EU on Waste Electrical and Electronic Equipment (WEEE) as amended, this symbol indicates that the product should be collected separately for recycling. Do not dispose of as unsorted municipal waste. Contact local distributor for disposal information. Ensure infected equipment is decontaminated prior to recycling.
	The Rechargeable Battery Recycling Corporation (RBRC) is a non-profit, public service organization that promotes the recycling of portable rechargeable batteries. Batteries must be delivered to a battery collection site. Visit the RBRC website (www.rbrc.org) to find a nearby collection site or call the phone number shown on the recycling symbol.
	Two person lift
	This way up

	Fragile, handle with care
	Keep dry
	Stacking limit by number
D C T - +	Battery terminal identification (D - data (SMBus data line), C-clock (SMBus clock line), T- T-Pin or temperature, - negative terminal, + positive terminal)
2800 mAh/71.68 Wh	Battery capacity and duration
	Cot duty cycle: 16.7%
U.S.A.	English text below this symbol is intended for USA audiences only
	Distributed by in the US
MADE IN U.S.A.	Product made in the United States of America
	Box manufacturer's certificate
	The Alvarium charger complies with the requirements of UL 62368-1:2019 Ed. 3 and CSA C22.2#62368-1:2019 Ed. 3 for audio/video, information and communication technology equipment, The Alvarium battery complies with the requirements of UL 62133-2:2020 Ed. 1 and CSA C22.2#62133-2:2020 Ed. 1 for secondary lithium battery systems.
	The Alvarium battery complies with the requirements of UL 62133-2:2020 Ed. 1 and CSA C22.2#62133-2:2020 Ed. 1 for secondary lithium battery systems.
	Do not clean with bleach
	Shoulder restraint
	Double buckle waist restraint
	Single buckle waist restraint

	Thigh restraint
	Ankle restraint

Table of Contents

Warning/Caution/Note Definition	3
Summary of safety precautions	3
Introduction	7
Product description	7
Indications for use	7
Clinical benefits	7
Contraindications	8
Expected service life	8
Disposal/recycle	8
Specifications - Power-PRO 2	8
European REACH - Power-PRO 2	9
China RoHS - Power-PRO 2	10
Standards with required options	11
WiFi radio specifications option	12
Specifications - Alvarium	13
European REACH - Alvarium	13
China RoHS - Alvarium	14
Product illustration - Power-PRO 2	15
Product illustration - Alvarium	16
Contact information	16
Serial number location - Power-PRO 2	17
Serial number location - Alvarium	17
Date of manufacture	17
Setup	18
Installation	19
Installing the cot fastener	19
Installing the in-fastener shut-off	19
Selecting the vehicle safety hook	20
Vehicle configuration	21
Positioning of the vehicle safety hook, front to back	22
Positioning of the vehicle safety hook, side to side	23
Installing the vehicle safety hook	24
Operating guidelines	26
Operation	27
Checking the battery power level	27
Transferring the patient to the cot	27
Raising or lowering the cot	28
Raising or lowering the cot manually with the manual override	29
Applying or releasing a wheel lock or Steer-Lock	29
Rolling the cot with a patient	30
Pushing or pulling the cot with the transport handle	30
Loading the cot into a vehicle	31
Unloading the cot from a vehicle	33
Positioning operators and helpers	34
Raising or lowering the backrest	35
Raising or lowering the siderails	35
Raising or lowering the siderails (XPS option)	35
Extending or retracting the retractable head section	36
Extending or retracting the retractable foot section	36
Raising or lowering the footrest	37
Raising or lowering the knee Gatch	37
Securing the patient with the X-restraint/XPR® restraint straps	38
Attaching the X-restraint/XPR shoulder restraints	39
Attaching the X-restraint/XPR waist restraints	40
Attaching the X-restraint/XPR thigh restraints	40

Attaching the X-restraint/XPR ankle restraints	41
Adjusting restraint straps	41
Adding a restraint strap extension	42
Securing the child restraint with the X-restraint package.....	42
Hanging equipment from the equipment hook	43
Positioning the two-stage IV pole option.....	44
Positioning the three-stage IV pole option	45
Attaching an oxygen bottle to the oxygen bottle holder option	46
Attaching the base storage net option	46
Attaching the backrest storage pouch option	47
Attaching the head end storage flat option.....	47
Attaching the mattress.....	47
Inserting the battery	48
Removing the battery from the product	48
Storing the battery.....	49
Charging the battery.....	49
Electrical power requirements	50
Charger setup.....	50
Securing the charger mounting plate option	50
Securing the charger to the charger mounting plate option	51
Powering the charger	52
Disconnecting the charger	53
Accessories and parts	54
Preventive maintenance	56
Lubrication	56
Regular inspection and adjustments.....	56
Every month or two hours	56
Every three months or six hours.....	57
Every six months or 12 hours	57
Every 12 months or 24 hours.....	58
Cleaning and disinfecting with SideKick®	60
Cleaning and disinfecting the XPR restraint straps.....	61
Cleaning the product.....	62
Disinfecting the product	63
Cleaning the charger	64
Cleaning the battery	64
Wireless notifications	65
Wireless coexistence notifications	65
EMC information	67

Warning/Caution/Note Definition

The words **WARNING**, **CAUTION**, and **NOTE** carry special meanings and should be carefully reviewed.

WARNING

Alerts the reader about a situation which, if not avoided, could result in death or serious injury. It may also describe potential serious adverse reactions and safety hazards.

CAUTION

Alerts the reader of a potentially hazardous situation which, if not avoided, may result in minor or moderate injury to the user or patient or damage to the product or other property. This includes special care necessary for the safe and effective use of the device and the care necessary to avoid damage to a device that may occur as a result of use or misuse.

Note - Provides special information to make maintenance easier or important instructions clearer.

Summary of safety precautions

Always read and strictly follow the warnings and cautions listed on this page. Service only by qualified personnel.

WARNING

- This product can expose you to chemicals including Nickel, which is known to the State of California to cause cancer, and Bisphenol A (BPA), which is known to the State of California to cause birth defects or other reproductive harm. For more information go to www.P65Warnings.ca.gov.
- Always install the in-fastener shut-off system (if not using a crash-rated cot fastener) in any emergency vehicle that will be used with this cot.
- Always install the cot fastener by qualified personnel only. Improper installation could result in injury to the patient or operator.
- Always make sure that all cots meet the installation specifications for the Stryker cot fastener system.
- Always adjust the rail clamp assembly to match the cot retaining post position for the cot manufacturer and model number.
- Always position the in-fastener shut-off before you place the cot into service.
- Do not attempt to operate the cot when loaded into a cot fastener.
- Always use the in-fastener shut-off to disable the electronic functionality only.
- Always adjust the mounting location to maintain the proper position of the vehicle safety hook face when you replace an existing vehicle safety hook with a new style.
- Always have a certified mechanic, familiar with ambulance vehicle construction, install the vehicle safety hook to avoid injury to the patient or operator.
- Always consult the vehicle manufacturer before you install the vehicle safety hook. Make sure that the installation of the vehicle safety hook does not damage or interfere with the brake lines, oxygen lines, fuel lines, fuel tank, or electrical wiring of the vehicle.
- Do not modify the cot or the vehicle safety hook. If the cot safety bar does not connect with the vehicle safety hook in any of these positions (left, center, or right), modify the vehicle.
- Always make sure that the cot safety bar connects with the vehicle safety hook every time before you install the vehicle safety hook.
- Always make sure that the cot safety bar connects with the vehicle safety hook before you remove the cot from the vehicle patient compartment to avoid the risk of injury.
- Always use screws that are long enough to go through the vehicle patient compartment floor, washer, and nut, with at least two full threads in the nut. The socket head cap screw length depends on the thickness of the vehicle floor.
- Always operate the cot only when all persons are clear of the mechanisms. Entanglement in powered cot mechanisms can cause serious injury.
- Always inspect the battery for damage before every use.
- Do not allow untrained helpers to assist in the operation of the product.

- Always follow proper hand placement on hand grips. Keep all hands clear of the red safety bar pivots when you load, unload, or change the cot height position.
- Do not ride on the base of the cot.
- Do not transport the cot sideways to avoid the risk of a cot tip or injury. Always transport the cot in a lowered position, head end or foot end first to minimize the risk of a cot tip or injury.
- Always keep hands, fingers, and feet away from moving parts. Use caution when you place your hands and feet near the base tubes to raise or lower the cot.
- Always conduct patient monitoring when the cot is idle. If you hydraulically raise or lower the cot you may temporarily affect electronic patient monitoring equipment.
- Do not use the product if it has been involved in an accident to avoid the risk of injury due to product damage. Contact Stryker to determine if you need to replace the product.
- Do not unlock or remove the cot from the cot fastener during vehicle transport.
- Always center the patient and equipment or accessories. Lock adjustable features and intended lift points before you transport a patient on the product.
- Always inspect the product for damage if involved in an ambulance accident. Contact Stryker Customer Service or Technical Support for more information.
- Always use all restraint straps to secure the patient on the product. An unrestrained patient may fall from the product and be injured.
- Do not leave a patient unattended. Hold the product while a patient is on the product.
- Do not apply a wheel lock when a patient is on the product or when you move the product to avoid the risk of a cot tip or injury.
- Always secure the mattress to the product to avoid movement during patient transfer.
- Do not raise or lower the cot while you are on rough or uneven terrain.
- Do not replace or apply a wheel lock on a product with worn transport wheels that are less than 6 in. diameter.
- Always transport the cot at transport height or the lowest possible height to reduce the risk of a cot tip. If possible, obtain additional assistance or take an alternate route.
- Always avoid high obstacles, such as curbs, steps, or rough terrain to avoid the risk of a cot tip or injury.
- Always use the specified push/pull locations to reduce the risk of a cot tip or injury.
- Always stow and latch the transport handle before you load, unload, or use the transport handle to lift the cot.
- Always support the load of the patient, cot, and accessories after the weight is off of the ground.
- Always use two operators when a cot is occupied.
- Do not load the cot into a vehicle with the head section retracted when using a cot fastener. The cot may tip or not connect with the cot fastener.
- Always make sure that the cot is locked in the cot fastener before you load and unload. Injury may occur if the cot is not secure.
- Always try to load and unload the cot on level ground to reduce the risk of a cot tip or injury.
- Do not use the jog function to jog past the set cot load height after the cot safety bar connects with the vehicle safety hook.
- Do not pull or lift on the cot safety bar when you unload the cot.
- Do not press the extend (+) button until the safety bar connects with the vehicle safety hook.
- Always lock the head and foot sections into place before you operate the cot.
- Do not attach restraint straps to the base tubes, cross tubes, or litter skin.
- Do not allow the head end storage flat to interfere with the operation of the retractable head section, safety bar, or vehicle safety hook.
- Do not store items under the mattress. Items under the mattress may interfere with product operation.
- Do not remove the battery when the product is active.
- Do not attempt to open the battery pack for any reason, to avoid the risk of electric shock. If the battery pack case is cracked or damaged, do not insert it into the charger. Return damaged battery packs to a service center for recycling.
- Always avoid direct contact with a wet battery or battery enclosures. Contact may cause injury to the patient or operator.
- Do not insert a cracked or damaged battery into the charger. Return damaged batteries to a service center for recycling.
- Do not connect AC and DC power supplies to the battery at the same time to avoid the risk of fire or electric shock.
- Always have a certified mechanic, familiar with ambulance vehicle construction, secure the charger mounting plate option and charger.

- Always make sure that the charger mounting plate option is secured to the surface before use.
- Do not use bare hands to check for hydraulic leaks.
- Always follow these cleaning and disinfecting guidelines, in addition to your protocols, to maintain hygienic safety.
- Always use any appropriate personal protective equipment while power washing to avoid inhaling contagion. Power washing equipment may aerate contamination.
- Always wear rubber gloves, in addition to personal protective equipment, when cleaning the battery to reduce the risk of injury.
- Always disconnect the charger from the wall outlet before cleaning to avoid the risk of electrical hazards.
- Do not spray fluid directly onto the charger.
- Do not power wash the charger.
- Do not use solvents, lubricants, or other chemicals to clean the charger unless otherwise directed.
- Do not immerse the charger in liquid or allow liquid to collect on top of the charger to avoid the risk of electric shock.
- Always use only non-conductive materials to wipe the battery.
- Always avoid excessive water exposure to the battery terminals.
- Do not directly handle or make contact with the battery terminals while cleaning to avoid the risk of injury.
- Do not immerse the battery in liquid or allow liquid to collect on top of the battery to avoid the risk of electric shock.
- Do not use solvents, lubricants, or other chemicals to clean the battery unless otherwise directed.
- Do not power wash the battery.
- Portable RF communications equipment, including peripherals such as antenna cables and external antennas, should be used no closer than 12 inches (30 cm) to any part of **Power-PRO 2**, including cables specified by the manufacturer.
- Avoid stacking or placing other equipment adjacent to **Power-PRO 2** to prevent improper operation of the products. If such use is necessary, carefully observe the cot and the other equipment to verify proper operation.
- The use of accessories, transducers, and cables, other than those specified or provided by the manufacturer, could result in increased electromagnetic emissions or decreased electromagnetic immunity and result in improper operation.

CAUTION

- Improper usage of the product can cause injury to the patient or operator. Operate the product only as described in this manual.
- Do not modify the product or any components of the product. Modifying the product can cause unpredictable operation resulting in injury to patient or operator. Modifying the product also voids its warranty.
- Always set the cot load height before you place the cot into service.
- Always clear any obstacles that may interfere and cause injury to the operator or patient before operating the product.
- Do not use siderails as a patient restraint device.
- Always set the transport wheels safely on the ground when you unload the cot from the vehicle patient compartment to avoid the risk of product damage.
- Do not use siderails as a push/pull device or to steer the product.
- Do not sit or stand on the siderails (XPS option).
- Do not use the siderails (XPS option) as a patient transfer device or surface (for example, to slide a patient from the cot to another surface).
- Do not position patients with full weight on the siderails (XPS option).
- Do not use the siderails as a push/pull device or to steer the product.
- Do not entangle the restraint straps in the base frame when you raise or lower the cot.
- Do not load the equipment hook above the safe working load of 35 lb (15.8 kg).
- Always remove all accessories or equipment from the equipment hook when in the vehicle.
- Do not load the IV pole above the safe working load of 25 lb (11.3 kg).
- Do not load the oxygen bottle holder above the safe working load of 15 lb (6.8 kg).
- Do not use two oxygen bottle holders at the same time.
- Do not load the base storage net above the safe working load of 20 lb (9 kg).
- Always be careful when you retract the base to avoid damaging items that are stored in the base storage net.
- Do not load the single-sided backrest storage pouch above the safe working load of 10 lb (4.5 kg).
- Do not load the dual-sided backrest storage pouch above the safe working load of 20 lb (9 kg).
- Do not allow the storage pouch to interfere with the operation of the retractable head section.

- Do not load the head end storage flat above the safe working load of 40 lb (18 kg).
 - Always remove the battery if you do not intend to use the product for more than 24 hours or longer.
 - Always place the electrical charger power cord where it will not be stepped on, tripped over, or otherwise subjected to damage or stress.
 - Do not touch the battery receptacle terminals with metal objects.
 - Always grasp and pull the plug, not the cord, when you disconnect the charger to avoid the risk of damage to the electrical plug and cord.
 - Always use authorized parts to avoid the risk of product damage.
 - Do not lubricate the bearings in the X-frame as it will degrade the performance of the cot and may void its warranty.
 - Do not apply lubricants to the surfaces of the restraints.
 - Always remove the battery before you wash the product.
 - Do not clean, service, or perform maintenance while the product is in use.
 - Do not steam clean or ultrasonically clean the product.
 - Do not exceed 180 °F (82 °C) as the maximum water temperature.
 - Do not exceed 1500 psi (103.4 bar) as the maximum water pressure. If you are using a hand held wand to wash the product, keep the pressure nozzle at a minimum of 24 in. (61 cm) from the product.
 - Changes or modifications to the **Alvarium** Battery Management System, not expressly approved by Stryker, could void the user's authority to operate the equipment.
-

Introduction

This manual assists you with the operation or maintenance of your Stryker product. Read this manual before operating or maintaining this product. Set methods and procedures to educate and train your staff on the safe operation or maintenance of this product.

CAUTION

- Improper usage of the product can cause injury to the patient or operator. Operate the product only as described in this manual.
 - Do not modify the product or any components of the product. Modifying the product can cause unpredictable operation resulting in injury to patient or operator. Modifying the product also voids its warranty.
-

Note

- This manual is a permanent part of the product and should remain with the product even if the product is sold.
- Stryker continually seeks advancements in product design and quality. This manual contains the most current product information available at the time of printing. There may be minor discrepancies between your product and this manual. If you have any questions, contact Stryker Customer Service or Technical Support at 1-800-327-0770.

Product description

The Stryker **Power-PRO 2** is a powered ambulance cot that consists of a platform, including a mattress, mounted on a wheeled, retractable X-frame that is designed to support and transport a maximum weight of 700 lb (318 kg). The **Alvarium™** rechargeable battery powers the hydraulic lift system and allows operators to raise and lower the cot using the powered controls on the foot end lift bars.

The cot features low transport height capability. The cot has an adjustable load height feature to allow the cot to be set to different ambulance deck heights during loading and unloading. The cot is equipped with a manual back-up release handle to allow the operation of cot functions in the event of power loss.

Foot end LED lights illuminate transport areas and reflective markings aid in cot visibility. The cot is also equipped with the following: a retractable head section for 360 degree mobility in any height position, siderails, adjustable backrest, patient restraint straps, and standard mechanical steer and wheel locks. The cot can be equipped various optional accessories that assist with the transport of the patient. The cot litter can be articulated in multiple positions. The cot service interface allows service technicians to acquire cot data and update software.

Power-PRO 2 is compatible with, and can be inductively charged by, the Stryker **Power-LOAD®** and **Performance-LOAD®** fastening systems. **Power-PRO 2** is also compatible with mass casualty, wall mount, and floor mount fasteners.

Alvarium Battery Management System is comprised of a lithium iron phosphate battery pack and a universal charger. The rechargeable battery acts as a power source for the **Power-PRO 2** cot.

Indications for use

Power-PRO 2 is intended to transport a patient to or from an emergency or non-emergency location, primarily within an emergency transport vehicle, to a healthcare facility. **Power-PRO 2** is intended for adult, adolescent, and child occupants who can be effectively secured by patient restraint straps on the product. Intended operators include trained professionals (emergency medical services and medical care center personnel) and medical first responders.

Power-PRO 2 is not intended for extended stay, use as a hospital bed, or devices that modify air pressure, such as hyperbaric chambers.

Clinical benefits

Cot: patient transport

Fastener: support cot for transport

Cot and fastener system: support and transport patients

Contraindications

None known.

Expected service life

Power-PRO 2 has a 7 year expected service life under normal use conditions and with appropriate periodic maintenance.

Alvarium charger has a 7 year expected service life under normal use conditions.

Alvarium battery has a 2 year expected service life under normal use conditions.

Disposal/recycle

Always follow the current local recommendations and/or regulations governing environmental protection and the risks associated with recycling or disposing of the equipment at the end of its useful life.

Specifications - Power-PRO 2

	Note - Safe working load indicates the sum of the patient, mattress, and accessory weight.	700 lb	318 kg
Backrest articulation		0° to 75°	
Length	Extended	84 in.	213.4 cm
	Mid	81 in.	205.7 cm
	Retracted	60 in.	152.4 cm
Overall width		22.6 in	57.4 cm
Height ¹		Adjustable from 14.4 in. to 41 in.	Adjustable from 36.6 cm to 104 cm
Weight ²		130 lb	59 kg
Caster diameter/width		6 in./2 in.	15 cm/5 cm
Minimum operators required for loading/unloading an occupied cot		2	
Minimum operators required for loading/unloading an unoccupied cot		1	
Recommended fastener systems		Model 6390 Power-LOAD , Model 6392 Performance-LOAD , Model 6370 or 6377 floor mount, Model 6371 wall mount	
Recommended loading height		Up to 36 in.	Up to 91 cm
Recommended transport height (excluding mattress)		25 in.	63.5 cm
Hydraulic oil		Pentosin™ CFH 11S	

Power system	
Battery (650700080301)	25.6 VDC LiFePO4
Charger (650700450301)	100-240 VAC, 50/60 Hz, 1A
	12-34 VDC, 5A
Cot duty cycle	16.7%
Standards	ANSI/AAMI ES 60601-1, 60601-1-12, 60601-1-2, BS EN 1865-2, BS EN 1865-3, AS/NZS-4535, SAE J3027, BS EN-1789, BS EN 597-1, 16 CFR 1632 For standards that require specific options, see <i>Standards with required options</i> (page 11).

¹ Height is measured from bottom of mattress at seat section to ground level.

² Cot is weighed with one battery and without mattress and restraints.

Stryker reserves the right to change specifications without notice.

The yellow and black color scheme is a proprietary trademark of Stryker Corporation.

Labels may be unreadable from a viewing distance greater than 12 inches.

Power-PRO 2 is designed to conform to:

- NFPA-1917
- CAAS-GVS
- KKK-A-1822

Environmental condition	Operation	Storage and transportation
Temperature		
Relative humidity		
Atmospheric pressure		

European REACH - Power-PRO 2

In accordance with the European REACH regulation and other environmental regulatory requirements, the components that contain declarable substances are listed.

Description	Number	Substance of very high concern (SVHC) chemical name
Caster nut	6090-001-009	Lead
Cot comm board	650700080203	Octamethylcyclotetrasiloxane (D4)
Foot end interface board PCBA	650700080810	Lead, lead monoxide (lead oxide), diboron trioxide
Gas spring yoke	650700080178	Lead

Description	Number	Substance of very high concern (SVHC) chemical name
Gas spring yoke end	650700080179	Lead
Lift motor cable assembly	650700080868	Lead
Light module cable assembly	650700080890	Lead
Mattress, knee Gatch bolster	6500-002-150	(2H-benzotriazol2-yl)-4, 6-di-tert-pentylphenol
Mattress, knee Gatch bolster, grey	6506-002-150	(2H-benzotriazol2-yl)-4, 6-di-tert-pentylphenol
Mattress, knee Gatch bolster, XPS	6500-003-130	(2H-benzotriazol2-yl)-4, 6-di-tert-pentylphenol
Mattress, knee Gatch bolster, XPS, grey	6506-003-130	(2H-benzotriazol2-yl)-4, 6-di-tert-pentylphenol
NFMIC - shielded PCBA assembly	650700080830	Lead, lead monoxide (lead oxide), diboron trioxide
WiFi module	650700080202	Lead, lead-monoxide, diboron trioxide, cadmium, 1,3,5-tris(oxiranylmethyl)-1,3,5-triazine-2,4,6(1H,3H,5H)-trione, 2-benzyl-2-dimethylamino-4-morpholinobutyrophenone, 2-methyl-1-(4-methylthiophenyl)-2-morpholinopropan-1-one
HBC assembly	650700080800	Lead, lead monoxide (lead oxide), diboron trioxide, 2-methyl-1-(4-methylthiophenyl)-2-morpholinopropan-1-one

China RoHS - Power-PRO 2

Description	Number	Hazardous substances					
		Lead (Pb)	Mercury (Hg)	Cadmium (Cd)	Hexavalent chromium (Cr (VI))	Polybrominated biphenyls (PBB)	Polybrominated diphenyl ethers (PBDE)
Actuator assembly	650700020-027	O	X	X	X	X	X
Foot end interface board PCBA	650700080-810	O	X	X	X	X	X
Gateway 4.0 PCBA	521206000-900	O	X	X	X	X	X
Cot WiFi module	650700080-202	O	X	X	X	X	X
Base controller PCBA assembly	650700080-800	O	X	X	X	X	X

Description	Number	Hazardous substances					
		Lead (Pb)	Mercury (Hg)	Cadmium (Cd)	Hexavalent chromium (Cr (VI))	Polybrominated biphenyls (PBB)	Polybrominated diphenyl ethers (PBDE)
MTS sensor assembly	650700020-198	O	X	X	X	X	X
Caster nut	6090-001-009	O	X	X	X	X	X
Light module cable assembly	650700080-890	O	X	X	X	X	X
User interface bottom cable assembly	650700080-891	O	X	X	X	X	X
User interface top cable assembly	650700080-892	O	X	X	X	X	X

This table is prepared in accordance with the provisions of SJ/T 11364.

O: Indicates that said hazardous substance contained in all of the homogenous materials used for this part is below the limit requirement of GB/T 26572.

X: Indicates that said hazardous substance contained in at least one of the homogenous materials used for this part is above the limit requirement of GB/T 26572.

Enterprises may further provide in this box technical explanation for marking "X" based on their actual circumstances.

Standards with required options

To be compliant with the standards, you must use the following required options on your cot.

Crash-test standard	Option selection	
	Restraint package	Fastener
SAE J3027	X-restraint package (6500-001-430)	Performance-LOAD and Power-LOAD
BS EN 1789	X-restraint package (6500-001-430)	Performance-LOAD and Power-LOAD
AS/NZS 4535	X-restraint package (6500-001-430)	Power-LOAD

WiFi radio specifications option

Manufacturer/model	Silex SX-SDMAC-2832S+
Chipset	Qualcomm Atheros QCA9377-3
IEEE 802.11	a/b/g/n/ac
RF bands	2.4 GHz, 5 GHz
Encryption	AES and TKIP (TKIP is not supported with WPA2)
Authentication	WPA Personal/Enterprise and WPA2 Personal/Enterprise
802.1X	PEAP-MSCHAP - v2
Client certificates	Cannot accept or upload certificates
Supported data rates	802.11b/g: 1-54 Mbps 802.11a: 6-54 Mbps 802.11n: MCS0-7 802.11ac: MCS0-9 (compatible)
Hash function compatibility	SHA-1 and SHA-2 server side certificate recognition for PEAP-MSCHAP - v2
Channel plan	2.4 GHz: All channels supported 5 GHz: All channels supported (Recommend against the use of DFS and ISM channels)
Other	Leverage hospital SSID Support for 802.11r Support for Cisco CCX (Fast roaming)

Item	Specification - Chipset QCA9377-3 (Qualcomm Atheros)				Unit
	Band	Mode	Min	Max	
Operating frequencies	2.4GHz	11b	2412	2472	MHz
		11g/n/ac	2412	2472	MHz
		11g/n/ac	2422	2462	MHz
	5GHz	11a/n/ac	5180	5825	MHz
		11n/ac	5190	5795	MHz
		11ac	5210	5775	MHz
Frequency steps	2.4GHz	11b/g/n	5		MHz
	5GHz	11a/n/ac	20		MHz
		11n/ac	40		MHz
		11ac	80		MHz
Modulation types	Not applicable	11b	DSSS (DBPSK, DQPSK, CCK)		Not applicable

Item	Specification - Chipset QCA9377-3 (Qualcomm Atheros)				Unit
	Band	Mode	Min	Max	
	Not applicable	11a/g/n	OFDM (BPSK, QPSK, 16QAM, 64QAM)		Not applicable
	Not applicable	11ac	OFDM (BPSK, QPSK, 16QAM, 64QAM, 255QAM)		Not applicable
Maximum ERP	Not applicable	Not applicable	-8.648/21.352		dBW/dBm

Specifications - Alvarium

WARNING - This product can expose you to chemicals including Nickel, which is known to the State of California to cause cancer, and Bisphenol A (BPA), which is known to the State of California to cause birth defects or other reproductive harm. For more information go to www.P65Warnings.ca.gov.

	Charger (650700450301)	Battery (650700080301)
Electrical input	12-34 VDC, 5A	Not applicable
Electrical output	Not applicable	25.6 VDC LiFePO4
Height	6.09 in. 154.69 mm	3.62 in. 91.95 mm
Width	4.46 in. 113.28 mm	3.18 in. 80.77 mm
Length	7.79 in. 197.87 mm	6.05 in. 153.67 mm
Weight	1.55 lb 0.70 kg	2.15 lb 0.98 kg
Enclosure protection	Not applicable	IP36
Standards	IEC 62368	IEC 62133-2, IEC 60529: IP36, SAE J3043

Environmental condition	Operation	Charging	Storage and transportation
Temperature	32 °F (0 °C) to 104 °F (40 °C)	50 °F (10 °C) to 104 °F (40 °C)	-4 °F (-20 °C) to 140 °F (60 °C)
Relative humidity	30% to 75%	30% to 75%	10% to 75%
Atmospheric pressure	700 to 1060 hPa	700 to 1060 hPa	500 to 1060 hPa

Specifications are approximate and may vary from product to product or as a result of power supply fluctuations.

Hereby, Stryker declares that the radio equipment type short range device is in compliance with Directive 2014/53/EU. The full text of the EU declaration of conformity is available at the following internet address: <http://techweb.stryker.com/EMS/EU%20Declaration%20of%20Conformity/index.html>.

European REACH - Alvarium

In accordance with the European REACH regulation and other environmental regulatory requirements, the components that contain declarable substances are listed.

Description	Number	Substance of very high concern (SVHC) chemical name
Battery charger assembly	650700450301	Lead, lead compounds, diboron trioxide, bisphenol A (BPA), antimony oxide (antimony trioxide)
Battery charger PCBA	650700080820	Lead, diboron trioxide
12 VDC cable, automotive	6500-201-247	Lead, fatty acids, C16-18, lead salts, diarsenic pentaoxide

China RoHS - Alvarium

Description	Number	Hazardous substances					
		Lead (Pb)	Mercury (Hg)	Cadmium (Cd)	Hexavalent chromium (Cr (VI))	Polybrominated biphenyls (PBB)	Polybrominated diphenyl ethers (PBDE)
Battery charger PCBA	650700080-820	O	X	X	X	X	X

This table is prepared in accordance with the provisions of SJ/T 11364.

O: Indicates that said hazardous substance contained in all of the homogenous materials used for this part is below the limit requirement of GB/T 26572.

X: Indicates that said hazardous substance contained in at least one of the homogenous materials used for this part is above the limit requirement of GB/T 26572.

Enterprises may further provide in this box technical explanation for marking "X" based on their actual circumstances.

Product illustration - Power-PRO 2

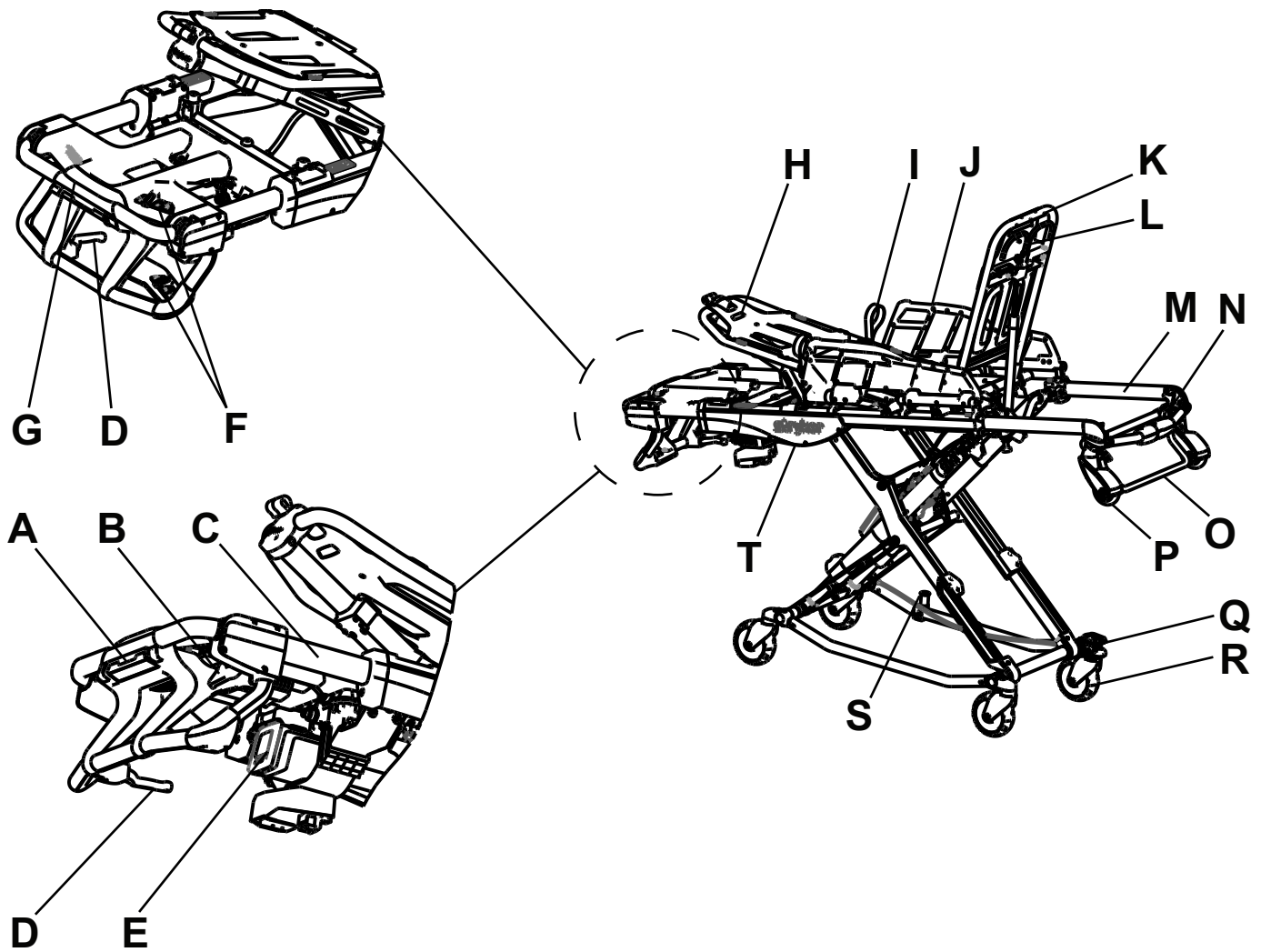

Figure 1 – Power-PRO 2

A	Foot end light
B	Foot section release lever
C	Retractable foot section
D	Manual back-up release handle
E	Battery
F	Cot control switch
G	Transport handle
H	Footrest
I	Red lifting loop
J	XPS siderail

K	Backrest
L	Backrest adjustment handle
M	Retractable head section
N	Head section release handle
O	Safety bar
P	Load wheel
Q	Wheel lock/Steer-Lock™
R	Transport wheel
S	Cot retaining post
T	Height sensor housing

Product illustration - Alvarium

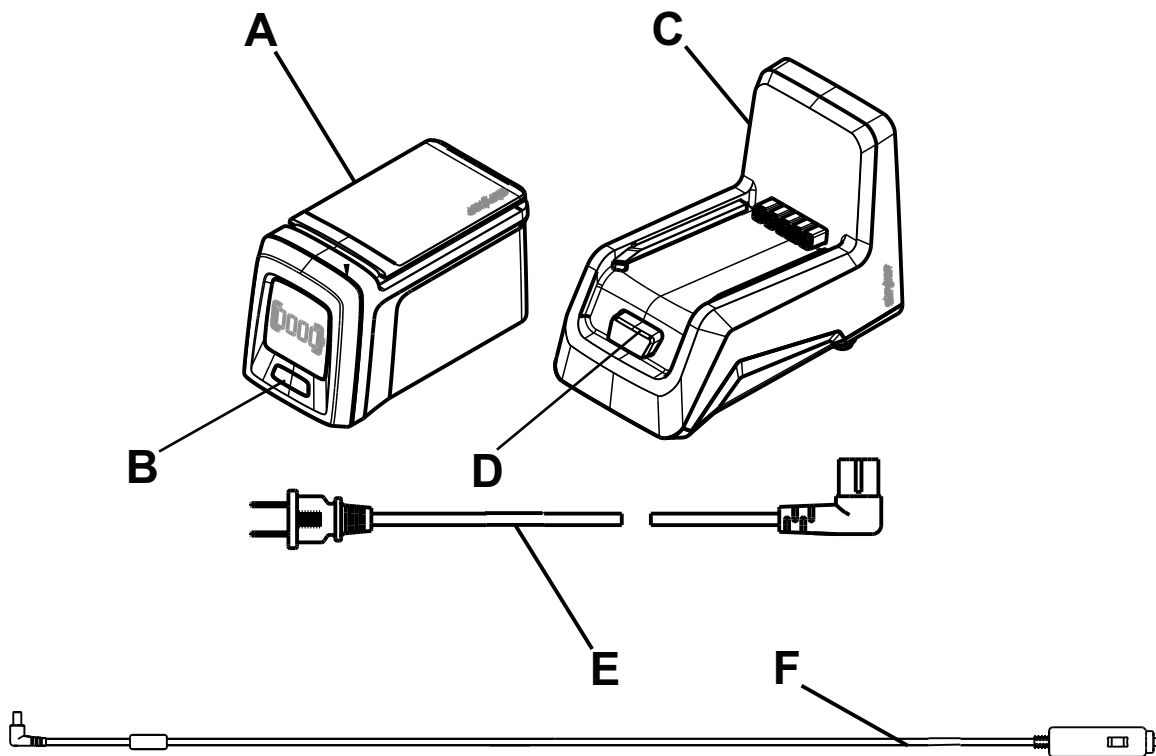

Figure 2 – Alvarium

A	Battery
B	Battery indicator button
C	Charger
D	Battery release button
E	AC power cord
F	DC power cord

Contact information

Contact Stryker Customer Service or Technical Support at: 1-800-327-0770.

Stryker Medical
 3800 E. Centre Avenue
 Portage, MI 49002
 USA

Note - The user and/or the patient should report any serious product-related incident to both the manufacturer and the Competent authority of the European Member State where the user and/or patient is established.

To view your operations or maintenance manual online, see <https://techweb.stryker.com/>.

Have the serial number (A) of your Stryker product available when calling Stryker Customer Service or Technical Support. Include the serial number in all written communication.

Serial number location - Power-PRO 2

See below for the cot (A) serial number location.

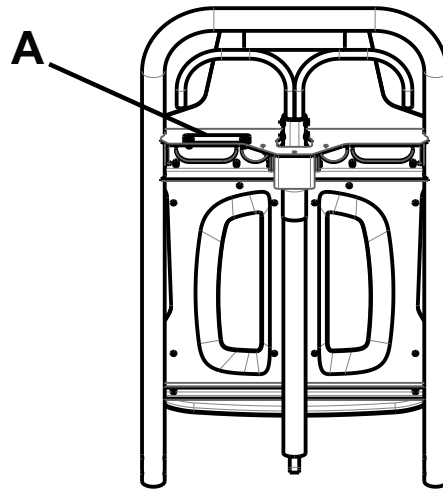

Serial number location - Alvarium

See below for the battery (B) and charger (C) serial number locations (Figure 3 and Figure 4).

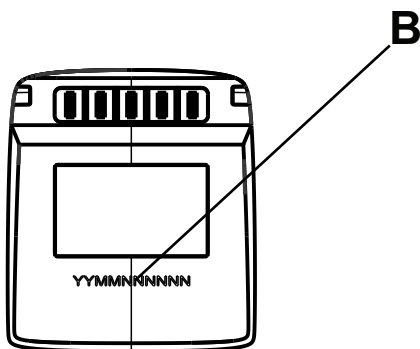

Figure 3 – Alvarium battery serial number location

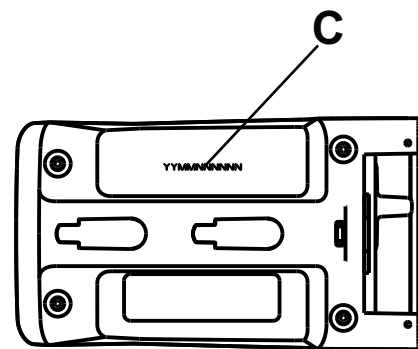

Figure 4 – Alvarium charger serial number location

Date of manufacture

The year of manufacture is the first 2 digits of the serial number.

Setup

During setup, unpack the cartons and check all items for proper operation. Confirm proper operation before you place the product into service.

WARNING - Always install the in-fastener shut-off system (if not using a crash-rated cot fastener) in any emergency vehicle that will be used with this cot.

Remove all the shipping and packaging materials from the product before use.

The vehicle patient compartment where the product will be used must have a:

- Smooth rear edge for loading
- Level floor large enough for the folded product
- Stryker cot fastener system
- Space to install the vehicle safety hook
- In fastener shut-off module installed, if using an antler style cot fastener

Note - Loose items or debris on the vehicle patient compartment floor can interfere with the operation of the vehicle safety hook and product fastener. Keep the vehicle patient compartment floor clear.

Unpack the battery and charger. Fully charge the battery before use.

Check the power cords, cables, and optional mounting brackets for any damage.

When necessary, modify the vehicle to fit the cot. Do not modify the cot.

Installation

Installing the cot fastener

The Stryker cot fastener systems are compatible only with cots that conform to the installation specifications.

WARNING

- Always install the cot fastener by qualified personnel only. Improper installation could result in injury to the patient or operator.
 - Always make sure that all cots meet the installation specifications for the Stryker cot fastener system.
 - Always adjust the rail clamp assembly to match the cot retaining post position for the cot manufacturer and model number.
-

These instructions are intended for cots with antler style cot fastener systems. For crash-rated cot fasteners, see the appropriate Operations Manual for installation instructions.

Installing the in-fastener shut-off

These instructions are intended for cots with antler style cot fastener systems. For crash-rated cot fasteners, see the appropriate Operations Manual for installation instructions.

WARNING

- Always position the in-fastener shut-off before you place the cot into service.
 - Do not attempt to operate the cot when loaded into a cot fastener.
 - Always use the in-fastener shut-off to disable the electronic functionality only.
 - Always install the in-fastener shut-off system (if not using a crash-rated cot fastener) in any emergency vehicle that will be used with this cot.
-

The cot and antler style cot fastener system have an integrated in-fastener shut-off function that disables the cot motor when you secure the cot into the cot fastener. Tighten the bolts to secure the fastener before you install the shut-off bracket. Install the shut-off bracket onto the rail clamp assembly before you place the cot into service.

1. Raise the base and push the cot into the vehicle patient compartment. Follow appropriate loading instructions.
2. Secure the extended head section of the cot into the cot fastener antler.
3. Secure the cot post into the fastener rail clamp.
4. Adjust the shut-off bracket along the rail clamp until the diamond (A) on the outer rail label is centered between the pop rivet heads (B) on the in-ambulance shut-off (Figure 5).
5. Using a T27 Torx driver, fasten the bolts to attach the shut-off bracket to the rail clamp assembly.
6. Press the retract (-) button to check that the motor does not turn on while the cot is in the fastener. The cot battery LED indicator will still illuminate. If the motor turns on, readjust the shut-off bracket.

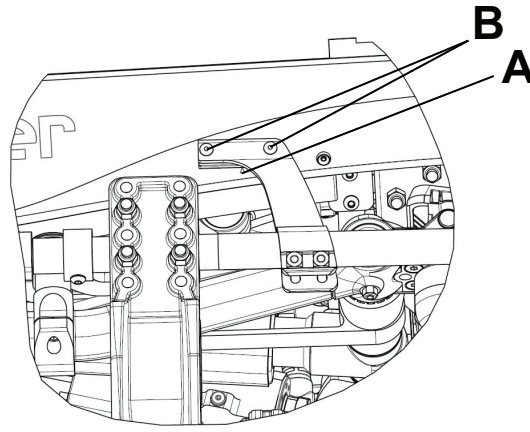

Figure 5 – Adjust the shut-off bracket

Selecting the vehicle safety hook

The vehicle safety hook is a device that ships with the cot. The cot safety bar and vehicle safety hook keep the cot from being accidentally removed from the vehicle and provide increased operator assurance and confidence when loading and unloading.

WARNING - Always adjust the mounting location to maintain the proper position of the vehicle safety hook face when you replace an existing vehicle safety hook with a new style.

Note - These instructions are intended for cots with antler style cot fastener systems. For crash-rated cot fasteners, see the appropriate Operations Manual for installation instructions. Crash-rated cot fasteners are shipped and installed with a vehicle safety hook, so no additional hook is needed.

The vehicle safety hook was designed for compatibility and proper operation when loading and unloading the cot from a vehicle that is compliant with Federal Regulation KKK-A-1822. Stryker offers three different types of vehicle safety hooks that are ordered and shipped with your cot. These vehicle safety hook types meet the needs of various emergency vehicle configurations, specifically the length and location of the floor structure support that is located in the rear of the vehicle.

To select which vehicle safety hook is appropriate for your vehicle configuration:

- Consider the location of the floor structure support where there is adequate room to mount the vehicle safety hook.
- Mount the vehicle safety hook into the back of the vehicle. Provide bumper clearance to allow the operators to load and unload the cot from the vehicle.
- Note the differences in vehicle design. Each vehicle safety hook provides a different mounting location option to maintain the appropriate distance between the face of the vehicle safety hook and the edge of the door sill.

Due to the differences in vehicle dimensions and the floor structure support locations, each vehicle safety hook allows for a different mounting location. Select the correct position for your vehicle safety hook installation.

- *Positioning of the vehicle safety hook, front to back* (page 22)
- *Positioning of the vehicle safety hook, side to side* (page 23)

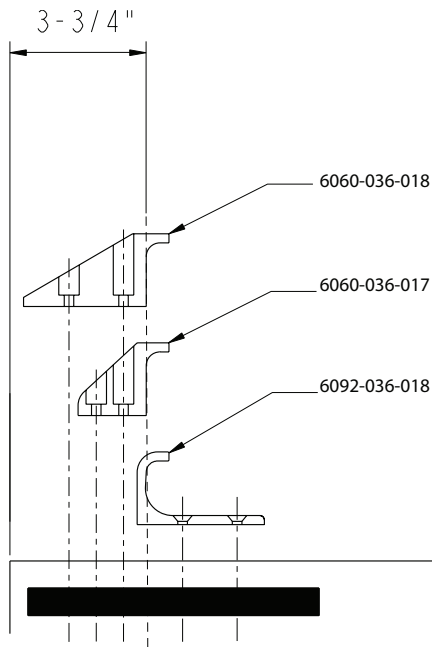

Figure 6 – Vehicle safety hook types

Vehicle configuration

WARNING

- Always have a certified mechanic, familiar with ambulance vehicle construction, install the vehicle safety hook to avoid injury to the patient or operator.
- Always consult the vehicle manufacturer before you install the vehicle safety hook. Make sure that the installation of the vehicle safety hook does not damage or interfere with the brake lines, oxygen lines, fuel lines, fuel tank, or electrical wiring of the vehicle.

CAUTION - Always set the cot load height before you place the cot into service.

The cot is compatible with all vehicle deck heights that meet the Federal Specification for the Star-of-Life Ambulance KKK-A-1822. See specifications for maximum load height.

According to Federal Specification for the Star-of-Life Ambulance KKK-A-1822:

- The rear of the ambulance shall be furnished with a sturdy, full-width, rear bumper, with a step secured to the vehicle's chassis frame.
- The tread of the step shall have a minimum depth of 5 in. (13 cm) and a maximum depth of 10 in. (25 cm).
- If the step protrudes more than 7 in. (18 cm) from the rear of the vehicle, a fold-up step shall be furnished.

According to Federal Specification for the Star-of-Life Ambulance KKK-A-1822, the bumper height of the vehicle shall be installed equidistant ± 2 in. (± 5 cm) from the vehicle floor to the ground level, which is defined as the vehicle deck height. Installation of the vehicle safety hook into any vehicle compliant with this federal specification provides adequate clearance for the cot base to lower to its fully extended position.

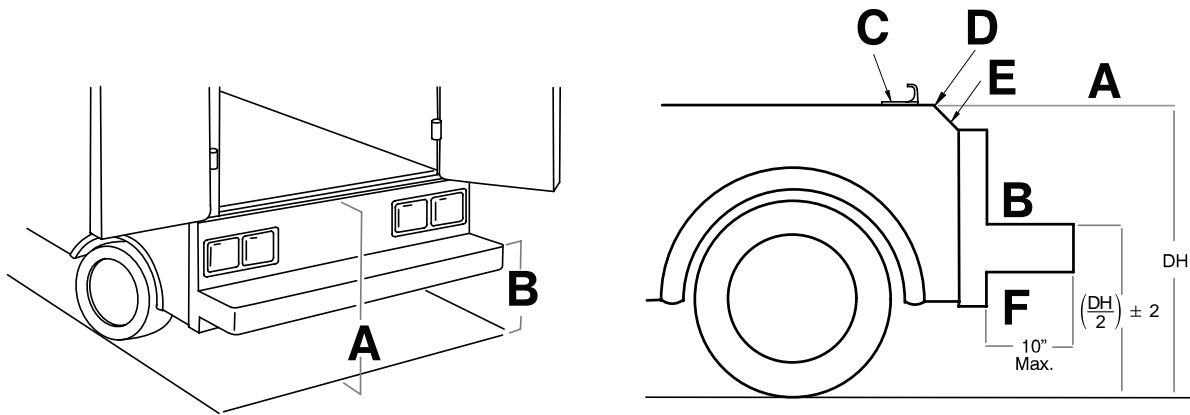

Figure 7 – Deck and bumper height

A	Deck height (DH)
B	Bumper height
C	Vehicle safety hook
D	Sill edge
E	Sill
F	Bumper depth

Positioning of the vehicle safety hook, front to back

Before vehicle safety hook installation, check the front to back and side to side positioning when you unload and load the cot.

To check the front to back positioning:

1. Select the appropriate vehicle safety hook. See *Selecting the vehicle safety hook* (page 20).
2. Position the vehicle safety hook at least 3-3/4 in. from the leading edge of the door sill (A) (Figure 8). The recommended distance from the face of the safety hook is no less than 3-3/4 in.
3. Check that you can secure the vehicle safety hook to the mount in the back of the vehicle.
4. Check that you have adequate bumper clearance to allow the cot to be loaded and unloaded from the vehicle.
5. Confirm the side to side placement of the vehicle safety hook. See *Positioning of the vehicle safety hook, side to side* (page 23).

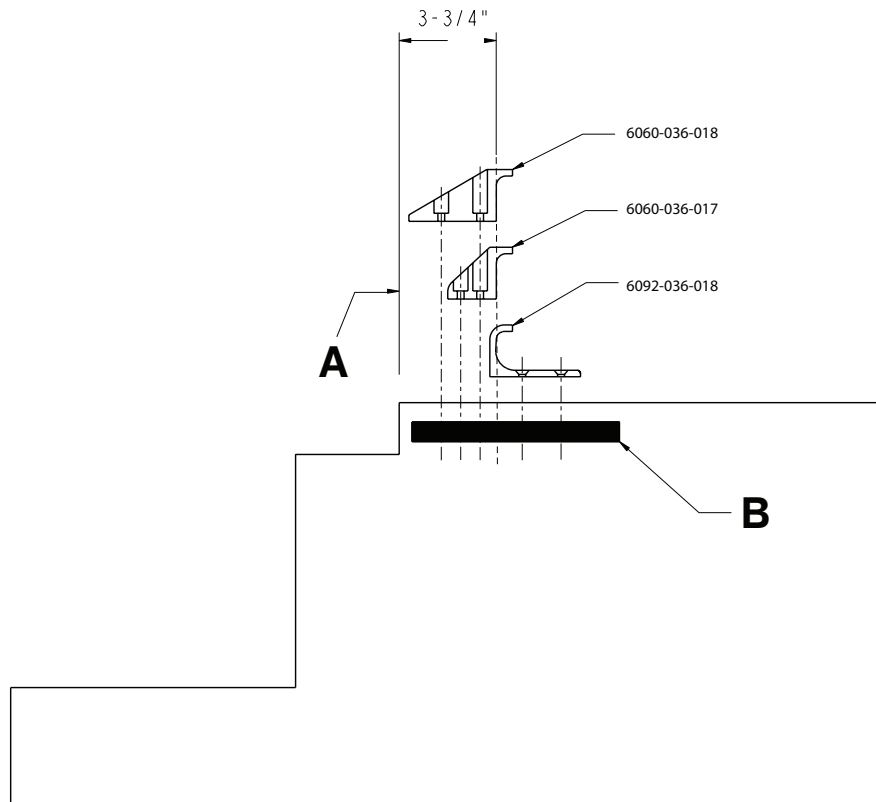

Figure 8 – Vehicle safety hook placement

A	Sill
B	Floor structure support

Positioning of the vehicle safety hook, side to side

Before vehicle safety hook installation, check the front to back and side to side positioning when you unload and load the cot.

WARNING

- Do not modify the cot or the vehicle safety hook. If the cot safety bar does not connect with the vehicle safety hook in any of these positions (left, center, or right), modify the vehicle.
- Always make sure that the cot safety bar connects with the vehicle safety hook every time before you install the vehicle safety hook.

To check the side to side positioning:

1. Remove the cot from the cot fastener and unload it from the vehicle.

Note - Pay attention to the position of the cot load wheels and the cot safety bar when you remove the cot.

2. Mark the center of the cot safety bar on the vehicle floor.
3. Check that the position marked in step 2 is where the cot safety bar connects with the vehicle safety hook every time when you unload the cot in a variety of positions (such as all the way to the left and all the way to the right).

Installing the vehicle safety hook

Before vehicle safety hook installation, the certified mechanic should plan for the placement of the vehicle safety hook in the rear of the vehicle patient compartment.

WARNING

- Always have a certified mechanic, familiar with ambulance vehicle construction, install the vehicle safety hook to avoid injury to the patient or operator.
 - Always consult the vehicle manufacturer before you install the vehicle safety hook. Make sure that the installation of the vehicle safety hook does not damage or interfere with the brake lines, oxygen lines, fuel lines, fuel tank, or electrical wiring of the vehicle.
 - Always make sure that the cot safety bar connects with the vehicle safety hook before you remove the cot from the vehicle patient compartment to avoid the risk of injury.
 - Always use screws that are long enough to go through the vehicle patient compartment floor, washer, and nut, with at least two full threads in the nut. The socket head cap screw length depends on the thickness of the vehicle floor.
-

Hardware required (not supplied):

- (2) Grade 5, minimum 1/4"-20 socket head cap screws * for the short vehicle safety hook or long vehicle safety hook
 - (2) Grade 5, minimum 1/4"-20 flat socket head cap screws * for the J vehicle safety hook
 - (2) Flat washers
 - (2) Lock washers
 - (2) 1/4"-20 nuts
1. Determine the correct vehicle safety hook front to back and side to side positioning, so the cot safety bar connects to the vehicle safety hook every time.
 - *Positioning of the vehicle safety hook, front to back* (page 22)
 - *Positioning of the vehicle safety hook, side to side* (page 23)
 2. Drill the holes for the screws.
 3. Fasten the vehicle safety hook to the vehicle patient compartment floor.
 4. Check that the cot safety bar connects with the vehicle safety hook before you remove the cot from the vehicle patient compartment.

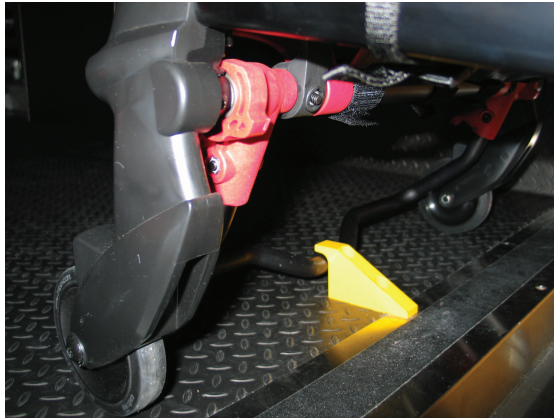

Figure 9 – Safety bar secured in the vehicle safety hook

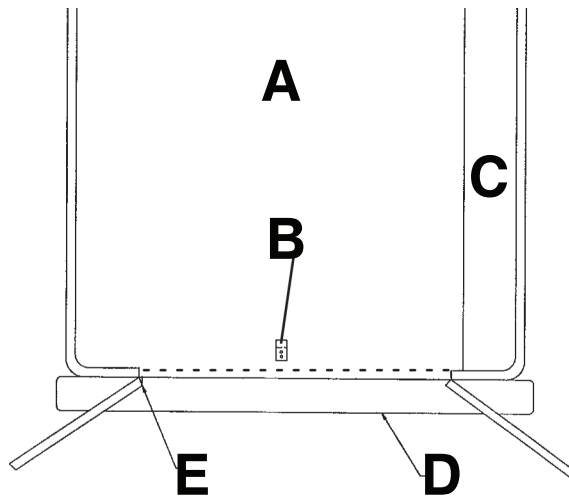

Figure 10 – Vehicle safety hook placement

A	Top view of vehicle
B	Vehicle safety hook
C	Squad bench
D	Bumper
E	Door frame

After installation, check that the cot legs lock into the load position without contacting the vehicle bumper.

Operating guidelines

WARNING

- Always operate the cot only when all persons are clear of the mechanisms. Entanglement in powered cot mechanisms can cause serious injury.
 - Always inspect the battery for damage before every use.
 - Do not allow untrained helpers to assist in the operation of the product.
 - Always follow proper hand placement on hand grips. Keep all hands clear of the red safety bar pivots when you load, unload, or change the cot height position.
 - Do not ride on the base of the cot.
 - Do not transport the cot sideways to avoid the risk of a cot tip or injury. Always transport the cot in a lowered position, head end or foot end first to minimize the risk of a cot tip or injury.
 - Always keep hands, fingers, and feet away from moving parts. Use caution when you place your hands and feet near the base tubes to raise or lower the cot.
 - Always install the in-fastener shut-off system (if not using a crash-rated cot fastener) in any emergency vehicle that will be used with this cot.
 - Always conduct patient monitoring when the cot is idle. If you hydraulically raise or lower the cot you may temporarily affect electronic patient monitoring equipment.
 - Do not use the product if it has been involved in an accident to avoid the risk of injury due to product damage. Contact Stryker to determine if you need to replace the product.
 - Do not unlock or remove the cot from the cot fastener during vehicle transport.
 - Always center the patient and equipment or accessories. Lock adjustable features and intended lift points before you transport a patient on the product.
 - Do not attempt to operate the cot when loaded into a cot fastener.
 - Always inspect the product for damage if involved in an ambulance accident. Contact Stryker Customer Service or Technical Support for more information.
-

CAUTION - Always clear any obstacles that may interfere and cause injury to the operator or patient before operating the product.

- Operate the product only as described in this manual.
- Read all labels and instructions on the product before use.
- Practice changing height positions and loading the cot until you understand the operation of the product.

Operation

Checking the battery power level

A charged battery, in working condition, provides at least 14 lifts with a 250 lb (113.4 kg) patient (actual results may vary).

The charger LED indicator bars show the battery power level.



Figure 11 – Battery power level

Status	Battery LED indicator
Discharging	Four LED bars = 76-100% charge Three LED bars = 51-75% charge Two LED bars = 26-50% charge One LED bar = 15-25% charge
Low battery	<15% charge One LED blinks five times, repeated two to three times
Charging	LED indicating current charge percentage is blinking
Error	Press LED indicator button and outermost LEDs blink five times, repeated three times See <i>Troubleshooting</i> in the Maintenance Manual

Note

- Use only Stryker approved batteries.
- Lock the cot into the powered cot fastener to automatically charge the battery. There are no cables or connectors required to charge.

Transferring the patient to the cot

WARNING

- Always use all restraint straps to secure the patient on the product. An unrestrained patient may fall from the product and be injured.

- Do not leave a patient unattended. Hold the product while a patient is on the product.
- Do not apply a wheel lock when a patient is on the product or when you move the product to avoid the risk of a cot tip or injury.
- Always secure the mattress to the product to avoid movement during patient transfer.

CAUTION - Do not use siderails as a patient restraint device.

To transfer the patient to the cot:

1. Roll the cot to the patient (*Rolling the cot with a patient* (page 30)).
2. Place the cot beside the patient. Raise or lower the cot to the level of the patient.

Note - It is recommended to transfer the patient with the cot at the lowest possible height.
3. Lower the siderails and open the restraint straps.
4. Transfer the patient to the cot. Follow accepted EMS procedures.
5. Secure the patient to the cot with all of the restraint straps.
6. Raise the siderails and adjust the backrest and footrest as necessary.

Raising or lowering the cot

You can raise or lower an unoccupied cot with one operator. If a patient is on the cot, a minimum of two trained operators are required to raise or lower the cot (one located at each end of the cot).

WARNING

- Always keep hands, fingers, and feet away from moving parts. Use caution when you place your hands and feet near the base tubes to raise or lower the cot.
- Always follow proper hand placement on hand grips. Keep all hands clear of the red safety bar pivots when you load, unload, or change the cot height position.
- Do not raise or lower the cot while you are on rough or uneven terrain.

There are two identical cot control switches located on your **Power-PRO 2** cot. Press the button on either of these switches to raise (extend) the cot, lower (retract) the cot, or release the cot from **Power-LOAD**, if applicable (Figure 12).

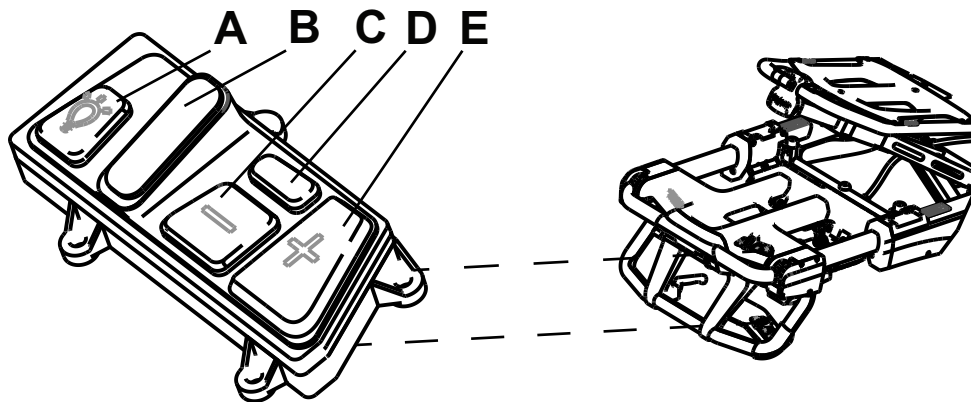

Figure 12 – Cot control switches

Reference	Name	Description
A	Foot end light	Press to turn the foot end light on or off
B	Indicator light	Illuminates when you reach transport height (see item D)

Reference	Name	Description
C	Retract (-)	Press and hold to lower the litter or retract the cot undercarriage
D	Release or transport height	Press to unlock the cot (this function operates only when within range of a Power-LOAD cot fastener) Press to raise or lower the cot to transport height Note - The cot will stop moving when you reach transport height.
E	Extend (+)	Press and hold to raise the litter or extend the cot undercarriage

Raising or lowering the cot manually with the manual override

In the event of loss of electrical function, you can use the cot manual override. This allows manual operation of the cot until the restoration of the electrical, powered functions. Use the red manual back-up release handle to raise or lower the cot.

WARNING

- Always keep hands, fingers, and feet away from moving parts. Use caution when you place your hands and feet near the base tubes to raise or lower the cot.
- Always follow proper hand placement on hand grips. Keep all hands clear of the red safety bar pivots when you load, unload, or change the cot height position.
- Do not raise or lower the cot while you are on rough or uneven terrain.

The manual back-up release handle is located along the patient right side of the lower lift bar at the foot end of the cot.

To raise or lower the cot with the manual back-up release handle:

1. Both operators: Lift the cot during the raise or lower operation to support the weight of the cot at each end.
2. Operator 1 (foot end):
 - a. Pull the manual back-up release handle toward the lift bar.
 - b. While you pull the manual back-up release handle, raise or lower the cot to the desired position.
 - c. Release the handle to lock the cot into position.

Note - Both operators must lift the cot weight off of the transport wheels to use the manual extend or retract while a patient is on the cot.

Applying or releasing a wheel lock or Steer-Lock

WARNING

- Do not apply a wheel lock when a patient is on the product or when you move the product to avoid the risk of a cot tip or injury.
- Do not replace or apply a wheel lock on a product with worn transport wheels that are less than 6 in. diameter.
- Do not leave a patient unattended. Hold the product while a patient is on the product.

Note - Wheel locks help prevent the product from rolling while unattended. Wheel locks may not provide sufficient resistance on all surfaces or under loads.

To apply a wheel lock (A), press the red pedal down and away from the middle of the cot X-frame (Figure 13).

To apply **Steer-Lock** (B), press the red pedal down and toward the middle of the cot X-frame (Figure 14).

To release a wheel lock or **Steer-Lock** (C), press down on the top of the pedal with your foot or lift up on the pedal with your toe (Figure 15). The top of the pedal will rest against the caster frame when you release the wheel lock or **Steer-Lock**.

Note - You can apply a wheel lock or **Steer-Lock** from the head end or foot end of the cot.

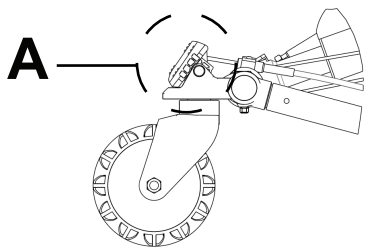

Figure 13 – Wheel lock on

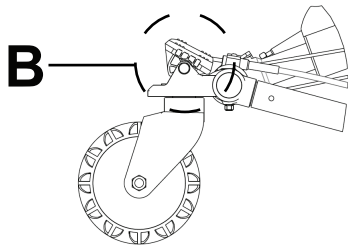

Figure 14 – Steer-Lock on

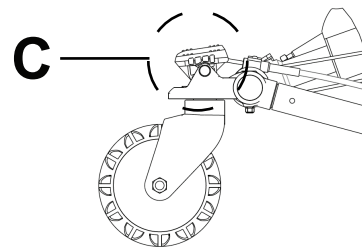

Figure 15 – Wheel lock and Steer-Lock off

Rolling the cot with a patient

WARNING

- Always transport the cot at transport height or the lowest possible height to reduce the risk of a cot tip. If possible, obtain additional assistance or take an alternate route.
- Always avoid high obstacles, such as curbs, steps, or rough terrain to avoid the risk of a cot tip or injury.
- Always center the patient and equipment or accessories. Lock adjustable features and intended lift points before you transport a patient on the product.
- Do not apply a wheel lock when a patient is on the product or when you move the product to avoid the risk of a cot tip or injury.
- Always use the specified push/pull locations to reduce the risk of a cot tip or injury.
- Always stow and latch the transport handle before you load, unload, or use the transport handle to lift the cot.

CAUTION - Do not use siderails as a patient restraint device.

To roll the cot with a patient:

1. Press the release or transport height button.

Note

- For patients who weigh 500 lb (227 kg) or less, use the transport height feature.
- For patients who weigh more than 500 lb (227 kg), transport at the lowest possible height.

2. Position one operator at the foot end and one operator at the head end of the cot.
3. Apply **Steer-Lock**. See *Applying or releasing a wheel lock or Steer-Lock* (page 29).
4. Lift each set of transport wheels over the door sill or obstacle separately.

Pushing or pulling the cot with the transport handle

WARNING

- Always transport the cot at transport height or the lowest possible height to reduce the risk of a cot tip. If possible, obtain additional assistance or take an alternate route.
- Always avoid high obstacles, such as curbs, steps, or rough terrain to avoid the risk of a cot tip or injury.

- Always center the patient and equipment or accessories. Lock adjustable features and intended lift points before you transport a patient on the product.
- Do not apply a wheel lock when a patient is on the product or when you move the product to avoid the risk of a cot tip or injury.
- Always use the specified push/pull locations to reduce the risk of a cot tip or injury.
- Always stow and latch the transport handle before you load, unload, or use the transport handle to lift the cot.

To push or pull the cot:

1. Press either one of the transport handle latch buttons and pull out the transport handle.
2. Check that the litter is perpendicular when you approach door sills or other low obstacles.
3. Lift each set of transport wheels over the door sill or obstacle separately.

Note - You can also lock the transport handle in the 90 degree upright position to push or pull the cot. See Figure 16, Figure 17, and Figure 18 for transport handle positions.

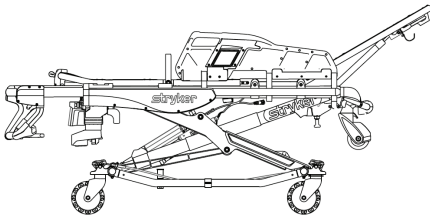

Figure 16 – Stowed (retracted)

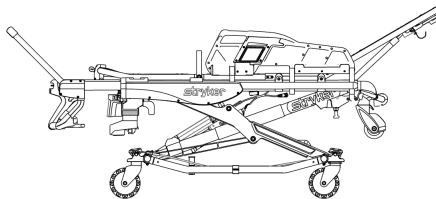

Figure 17 – Angled (extended)

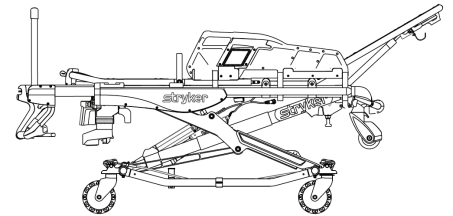

Figure 18 – Vertical (extended)

Loading the cot into a vehicle

Always load an occupied cot with a minimum of two trained operators. Two operators must be present when a cot is occupied. Operators must be able to lift the total weight of the patient, cot, and any items on the cot.

WARNING

- Always support the load of the patient, cot, and accessories after the weight is off of the ground.
- Always use two operators when a cot is occupied.
- Always follow proper hand placement on hand grips. Keep all hands clear of the red safety bar pivots when you load, unload, or change the cot height position.
- Do not load the cot into a vehicle with the head section retracted when using a cot fastener. The cot may tip or not connect with the cot fastener.
- Always make sure that the cot is locked in the cot fastener before you load and unload. Injury may occur if the cot is not secure.
- Always try to load and unload the cot on level ground to reduce the risk of a cot tip or injury.
- Do not use the jog function to jog past the set cot load height after the cot safety bar connects with the vehicle safety hook.
- Always operate the cot only when all persons are clear of the mechanisms. Entanglement in powered cot mechanisms can cause serious injury.
- Always stow and latch the transport handle before you load, unload, or use the transport handle to lift the cot.

CAUTION - Always clear any obstacles that may interfere and cause injury to the operator or patient before operating the product.

Stryker recommends that both operators are at the foot end to reduce the load on each operator. One or two operators can lift from the foot end of the cot. The operator must be able to lift the cot high enough for the cot legs to extend when the cot is unloaded.

Note

- You can load an unoccupied cot into a vehicle with one operator using the powered method.
- For information about using your cot with **Power-LOAD**, see the **Power-LOAD Operations Manual**.

To load a cot into a vehicle with an antler style cot fastener:

1. Extend and lock the retractable head section.
2. Stow and latch the transport handle.
3. Place the cot in a loading position.

Note - A loading position is any position where the load wheels meet the vehicle floor height.

4. Lift the vehicle bumper, if equipped, to the raised position.
5. Roll the cot to the open door of the vehicle patient compartment.
6. Push the cot forward until the load wheels are on the vehicle patient compartment floor and the cot safety bar passes the vehicle safety hook.
7. Pull the cot back until the cot safety bar connects to the vehicle safety hook for maximum clearance to lift the base.
8. Check that the cot safety bar connects with the vehicle safety hook.
9. Load the cot.

Note - Always use the powered method to load an unoccupied cot with one operator. Do not use the manual method to load an unoccupied cot with one operator.

- Powered method - using the cot control switches:

With both operators at the foot end (recommended method)	With one operator at the foot end and one operator on the side	With one operator (when loading an unoccupied cot)
<ol style="list-style-type: none"> a. Both operators: Grasp the cot frame at the foot end. b. Operator 1: Press and hold the retract (-) button to retract the cot undercarriage. 	<ol style="list-style-type: none"> a. Operator 1: Grasp the cot frame at the foot end and press and hold the retract (-) button to retract the cot undercarriage. b. Operator 2: Grasp the cot outer rail to stabilize the cot as the cot undercarriage retracts. 	<p>Grasp the cot frame at the foot end and press and hold the retract (-) button to retract the cot undercarriage.</p>

- Manual method - using the manual back-up release handle:

- a. Operator 1 (at the foot end):
 - i. Grasp the cot frame at the foot end.
 - ii. Lift the foot end of the cot until you lift the weight off of the cot base.
 - iii. Squeeze and hold the manual back-up release handle.
- b. Operator 2 (on the side):
 - i. Grasp the cot outer rail to stabilize the cot as you retract the cot undercarriage.
 - ii. Raise the cot undercarriage to the highest height position.

10. Push the cot into the vehicle patient compartment. Check that the foot section does not protrude from the vehicle or hit the door.

11. Make sure that the cot is locked into the cot fastener (not included) by firmly pulling side to side on the foot end of the cot.

Note - When you use the manual back-up release handle, do not lift the base rapidly or the movement may appear sluggish. Lift with a slow, constant motion.

Unloading the cot from a vehicle

Always unload an occupied cot with a minimum of two trained operators. Operators must be able to lift the total weight of the patient, cot, and any items on the cot.

WARNING

- Always support the load of the patient, cot, and accessories after the weight is off of the ground.
 - Always use two operators when a cot is occupied.
 - Always follow proper hand placement on hand grips. Keep all hands clear of the red safety bar pivots when you load, unload, or change the cot height position.
 - Always make sure that the cot safety bar connects with the vehicle safety hook before you remove the cot from the vehicle patient compartment to avoid the risk of injury.
 - Do not pull or lift on the cot safety bar when you unload the cot.
 - Always make sure that the cot is locked in the cot fastener before you load and unload. Injury may occur if the cot is not secure.
 - Always try to load and unload the cot on level ground to reduce the risk of a cot tip or injury.
 - Do not use the jog function to jog past the set cot load height after the cot safety bar connects with the vehicle safety hook.
 - Always operate the cot only when all persons are clear of the mechanisms. Entanglement in powered cot mechanisms can cause serious injury.
 - Always stow and latch the transport handle before you load, unload, or use the transport handle to lift the cot.
-

CAUTION

- Always set the transport wheels safely on the ground when you unload the cot from the vehicle patient compartment to avoid the risk of product damage.
 - Always clear any obstacles that may interfere and cause injury to the operator or patient before operating the product.
-

One or two operators can lift from the foot end of the cot. The operator must be able to lift the cot high enough for the cot legs to extend when the cot is unloaded.

Note - You can unload an unoccupied cot from a vehicle with one operator.

To unload the cot from a vehicle:

1. Lift the vehicle bumper, if equipped, to the raised position.

Note - The cot is equipped with bumper detection. An obstruction will stop the cot from moving even if you continue to hold the extend button. Remove the obstruction and press the extend button again to continue unloading. You may need to load the cot back into the vehicle to proceed.

2. Remove the cot from the cot fastener.
3. Unload the cot.
 - Powered method - using the cot control switches:

With both operators at the foot end	With one operator at the foot end and one operator on the side	With one operator (when unloading an unoccupied cot)
<p>a. Both operators: Grasp the cot frame at the foot end.</p> <p>b. Both operators: Pull the cot out of the vehicle patient compartment until the safety bar connects with the vehicle safety hook. WARNING - Do not press the extend (+) button until the safety bar connects with the vehicle safety hook.</p> <p>c. Operator 2: Make sure that the safety bar connects with the vehicle safety hook.</p> <p>d. Operator 1: Depress the extend (+) button to extend the cot undercarriage.</p> <p>e. Operator 2: Pull the safety bar release lever forward to remove the safety bar from the vehicle safety hook.</p>	<p>a. Operator 1: Grasp the cot frame at the foot end and pull the cot out of the vehicle patient compartment until the safety bar connects with the vehicle safety hook. WARNING - Do not press the extend (+) button until the safety bar connects with the vehicle safety hook.</p> <p>b. Operator 2: Grasp the cot outer rail to stabilize the cot.</p> <p>c. Operator 1: Depress the extend (+) button to extend the cot undercarriage.</p> <p>d. Operator 2: Pull the safety bar release lever forward to remove the safety bar from the vehicle safety hook.</p>	<p>a. Grasp the cot frame at the foot end.</p> <p>b. Pull the cot out of the vehicle patient compartment until the safety bar connects with the vehicle safety hook. WARNING - Do not press the extend (+) button until the safety bar connects with the vehicle safety hook.</p> <p>c. Depress the extend (+) button to extend the cot undercarriage.</p> <p>d. Pull the safety bar release lever forward to remove the safety bar from the vehicle safety hook.</p>

- Manual method - using the manual back-up release handle:

With both operators at the foot end (recommended method)	With one operator at the foot end and one operator on the side	With one operator (when unloading an unoccupied cot)
<p>a. Both operators: Grasp the cot frame at the foot end.</p> <p>b. Operator 1: Pull the manual back-up release handle to extend the cot undercarriage. Pull the cot out of the vehicle patient compartment until the safety bar connects with the vehicle safety hook. Release the manual back-up release handle when the base is fully extended.</p> <p>c. Operator 2: Make sure that the safety bar connects with the vehicle safety hook. Pull the safety bar release lever forward to remove the safety bar from the vehicle safety hook.</p>	<p>a. Operator 1: Grasp the cot frame at the foot end. Pull the manual back-up release handle to extend the cot undercarriage. Pull the cot out of the vehicle patient compartment until the safety bar connects with the vehicle safety hook. Release the manual back-up release handle when the base is fully extended.</p> <p>b. Operator 2: Make sure that the safety bar connects with the vehicle safety hook. Grasp the cot outer rail to stabilize the cot. Pull the safety bar release lever forward to remove the safety bar from the vehicle safety hook.</p>	<p>a. Grasp the cot frame at the foot end.</p> <p>b. Pull the manual back-up release handle to extend the cot undercarriage.</p> <p>c. Pull the cot out of the vehicle patient compartment until the safety bar connects with the vehicle safety hook.</p> <p>d. Release the manual back-up release handle when the base is fully extended.</p> <p>e. Pull the safety bar release lever forward to remove the safety bar from the vehicle safety hook.</p>

Positioning operators and helpers

WARNING - Always follow proper hand placement on hand grips. Keep all hands clear of the red safety bar pivots when you load, unload, or change the cot height position.

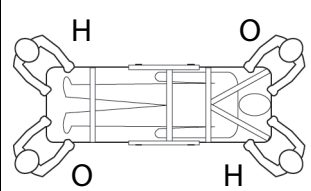
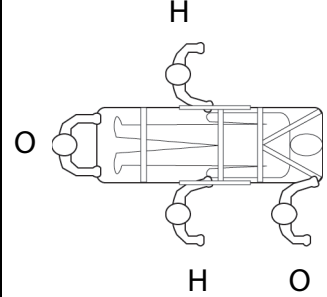
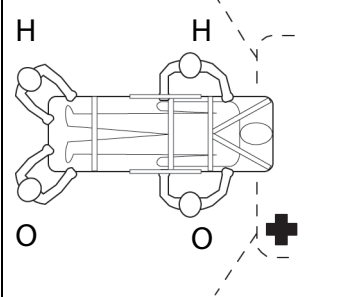
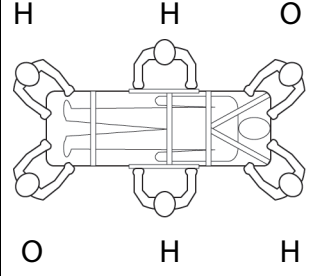
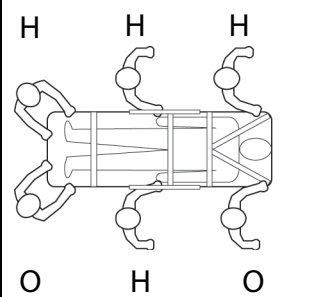
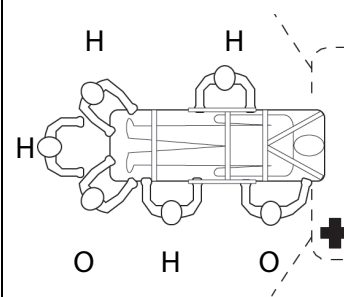
	Changing levels	Rolling	Loading and unloading
Two operators (O) Two helpers (H)			
Two operators (O) Four helpers (H)			

Raising or lowering the backrest

To raise the backrest, squeeze the backrest adjustment handle to move the backrest to the desired height.

To lower the backrest, squeeze the backrest adjustment handle while you push down on the backrest to the desired height.

Raising or lowering the siderails

Always lower the siderails when you transfer a patient to the cot or from the cot.

CAUTION

- Do not use siderails as a patient restraint device.
- Do not use siderails as a push/pull device or to steer the product.

To raise the siderails, lift up on the siderail until the latch clicks and the siderail locks into place. Always keep the siderails in the raised position unless you are transferring the patient.

To lower the siderails, squeeze the siderail release handle to release the siderail latch. Guide the siderail down toward the foot end of the cot until the siderail lays flat. Always lower the siderails when you transfer a patient to or from the cot.

Raising or lowering the siderails (XPS option)

You can order your cot with the expandable patient surface (XPS) option or upgrade your cot to add the XPS option.

CAUTION

- Do not use siderails as a patient restraint device.
- Do not sit or stand on the siderails (XPS option).
- Do not use the siderails (XPS option) as a patient transfer device or surface (for example, to slide a patient from the cot to another surface).
- Do not position patients with full weight on the siderails (XPS option).

- Do not use the siderails as a push/pull device or to steer the product.
-

Siderails (XPS option) attach to the cot and are always available for your use. The siderails (XPS option) adjust according to patient size and lock into seven positions. The siderails also adjust to fit through standard doorways or elevators.

To raise the siderails, lift up on the siderail until locked into the desired position.

To lower the siderails, lift up to relieve the weight, then pull the red lever. Always lower the siderails when you transfer a patient to or from the cot.

The XPS option is not a primary patient support surface. It includes a wider mattress and is intended to enhance patient comfort.

Extending or retracting the retractable head section

Extend the retractable head section before you load the cot into the vehicle patient compartment. Retract the retractable head section to roll the cot in any direction on the load wheels for improved mobility and maneuverability, even in the lowest position.

WARNING

- Always lock the head and foot sections into place before you operate the cot.
 - Do not load the cot into a vehicle with the head section retracted when using a cot fastener. The cot may tip or not connect with the cot fastener.
-

To extend or retract the retractable head section:

1. Grasp the outer rail with one hand for support and pull the head section release handle. Rotate the head section release handle toward the head end of the cot to release the head section from the locked position.
2. While you hold the head section release handle in the released position, pull the head section away from the litter frame. Extend or push the head section toward the litter frame to retract.
3. Release the head section release handle to lock the head section in either the extended or retracted position.
4. Pull the head section up and down to check that it is locked.

Extending or retracting the retractable foot section

WARNING - Always lock the head and foot sections into place before you operate the cot.

To extend or retract the retractable foot section:

1. Grasp the outer rail with one hand for support and pull the foot section release lever.
2. While you hold the foot section release lever, pull the foot section away from the litter frame. Extend or push the foot section toward the litter frame to retract.
3. Release the foot section release lever to lock the foot section in either the extended (Figure 19), mid (Figure 20), or retracted position (Figure 21).
4. Pull the foot section up and down to check that it is locked.

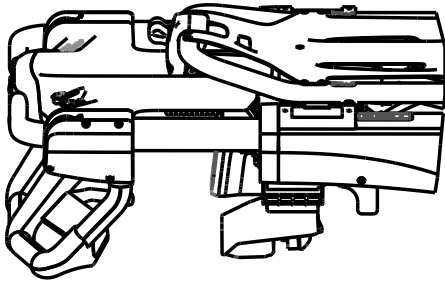

Figure 19 – Extended

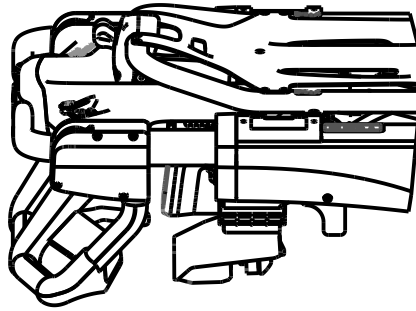

Figure 20 – Mid

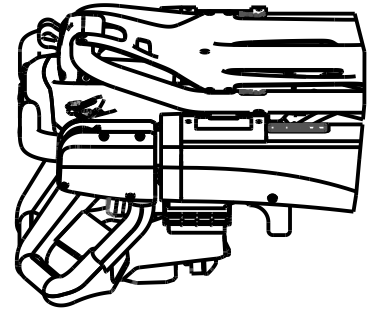

Figure 21 – Retracted

Raising or lowering the footrest

You can adjust the footrest to elevate the patient's legs.

To raise the footrest, lift the frame as high as possible. The support bracket automatically secures the frame when you release the footrest.

To lower the footrest, lift the frame and lift up on the footrest release handle (B) until the frame releases the support bracket (Figure 22). Lower the footrest until flat.

Raising or lowering the knee Gatch

To raise the knee Gatch:

1. Lift either of the red lifting loops (A) until the knee Gatch is in the highest position (Figure 22).
2. Lower the knee Gatch to secure the support bracket to the locking mechanism.
3. Check that the locking mechanism is secure before you release the red lifting loop.

To lower the knee Gatch, lift either of the red lifting loops (A) to relieve pressure on the locking mechanism. While you hold the red lifting loop, push on the red footrest release handle (B) until the support bracket is released. Lower the knee Gatch until flat.

To raise the knee Gatch in Trendelenburg, lift the footrest frame (C) as high as possible until the frame locks into place. The support bracket automatically connects when you release the frame.

To lower the knee Gatch in Trendelenburg, lift the footrest frame (C). While you hold the frame, lift up on the red footrest release handle (B) until the frame releases the support bracket. Lower the footrest until flat.

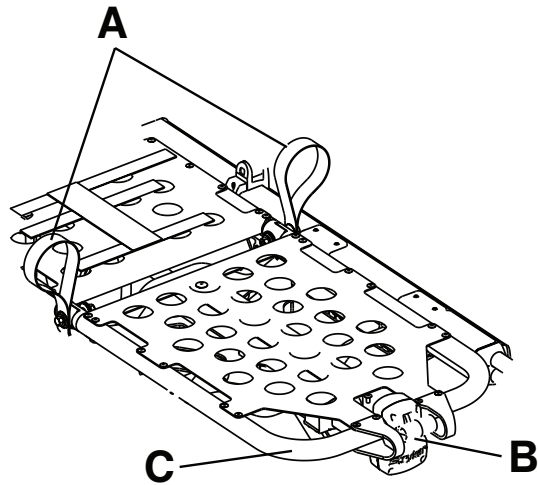

Figure 22 – Gatch

Securing the patient with the X-restraint/XPR® restraint straps

Secure restraint straps to the cot in the required attachment locations: shoulders, waist, thighs, and ankles. Power-PRO 2 cots are compatible with the X-restraint strap system.

WARNING

- Always use all restraint straps to secure the patient on the product. An unrestrained patient may fall from the product and be injured.
 - Do not attach restraint straps to the base tubes, cross tubes, or litter skin.
-

CAUTION - Do not entangle the restraint straps in the base frame when you raise or lower the cot.

Note - Restraint straps are a Type BF applied part.

Restraint strap attachment locations should provide strong anchorage and proper restraint position (Figure 23). If you do not use the restraint strap attachment locations shown below, the cot is not crash-rated.

Do not allow restraint straps to interfere with equipment or accessories. Buckle the restraints across the shoulders, waist, thighs, and ankles. Buckle all restraint straps when the cot is not in use.

1. *Attaching the X-restraint/XPR shoulder restraints* (page 39)
2. *Attaching the X-restraint/XPR waist restraints* (page 40)
3. *Attaching the X-restraint/XPR thigh restraints* (page 40)
4. *Attaching the X-restraint/XPR ankle restraints* (page 41)



Figure 23 – Restraint strap attachment locations

Attaching the X-restraint/XPR shoulder restraints

To attach the shoulder restraints (Figure 24):

1. Wrap the restraint around the cot frame where the matching label is located (Figure 25).
2. Pull the restraint buckle through the loop, toward the head end of the cot.
3. Feed the buckle under the XPS system.
4. Pull the restraint through tight and toward the back of the backrest.
5. Feed the buckle through the opening in the backrest.
6. Connect the patient right shoulder buckle to the patient left waist buckle.
7. Remove any slack from the restraint strap loop.



Figure 24 – Attaching the shoulder restraints



Figure 25 – Shoulder restraints location

Attaching the X-restraint/XPR waist restraints

To attach the waist restraints:

1. Wrap the restraint around the cot frame where the matching label is located (Figure 26).
2. Pull the restraint buckle through the loop, toward the head end of the cot.
3. Feed the buckle under the XPS system.
4. Pull the buckles tight. One restraint should angle toward the head end and one should lay straight across the cot.
5. Connect the patient right buckle to the patient left buckle.
6. Remove any slack from the restraint strap loop.



Figure 26 – Waist restraint location

Attaching the X-restraint/XPR thigh restraints

To attach the thigh restraint:

1. Wrap the restraint around the cot frame where the matching label is located (Figure 27).
2. Pull the restraint buckle through the loop, toward the head end of the cot.
3. Pull the restraint tight.
4. Connect the patient right buckle to the patient left buckle.
5. Remove any slack from the restraint strap loop.



Figure 27 – Thigh restraint location

Attaching the X-restraint/XPR ankle restraints

To attach the ankle restraints:

1. Wrap the restraint around the cot frame where the matching label is located (Figure 28).
2. Pull the restraint buckle through the loop, toward the head end of the cot.
3. Pull the buckle tight.
4. Connect the patient right buckle to the patient left buckle.
5. Remove any slack from the restraint strap loop.



Figure 28 – Ankle restraint location

Adjusting restraint straps

Open the restraint straps and place them at either side of the cot while you position the patient on the cot mattress. Lengthen the restraint straps, buckle them around the patient, and shorten them to tighten.

- To open the restraint strap, press the red button on the front of the buckle receiver. This allows you to release the buckle latch plate and pull it out of the receiver.
- To close the restraint strap, push the latch plate into the receiver until you hear a click.
- To lengthen the restraint strap, grasp the buckle latch plate, turn it at an angle to the webbing, then pull it out. A hemmed tab at the end of the webbing prevents the latch plate from coming off of the strap.
- To shorten the restraint strap, grasp the hemmed tab and pull the webbing back through the latch plate to tighten.

When you buckle a restraint strap around a patient, secure the latch plate and remove any loose webbing from the cot.

Inspect the restraint straps at least once a month (more if used often). Check for a bent or broken receiver or latch plate, or torn or frayed webbing. Replace any worn or inoperable restraint strap.

Adding a restraint strap extension

Add a restraint strap extension (6082-160-050) for extra length when you buckle the lap belt around larger patients.

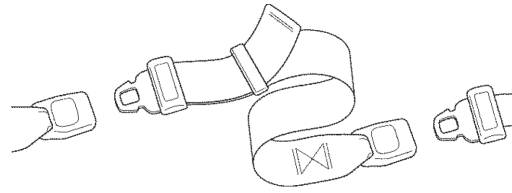

Figure 29 – Restraint strap extension

Securing the child restraint with the X-restraint package

To attach the Britax Meridian SICT (series no. 7200/A/2010), Britax Graphene Car Seat (series no. BS7300S-i20133), Platinum Pro SICT (series no. 7200/A/2013i), and Millenia SICT (series no. 7200/A/2013/i) Convertible Child Restraint to the cot with the X-restraint package (6500-001-430):

1. Lay the cot flat.
2. Open the waist restraint straps (6500-001-402 and 6500-001-403). Lay the straps to the side and out of the way.
3. Position the child restraint to face the foot end of the cot.
4. Place the child restraint in the reclined position.
5. Raise the cot Fowler up to align with the back of the child restraint.
6. Loop the upper anchorage strap with the anchor fitting and attachment clip from the child restraint around the cot Fowler (Figure 30). Pull the adjustment strap to tighten and remove slack.
7. Pull the waist restraint under the siderail and through the bottom of the child restraint (Figure 31).



Figure 30 – Anchorage strap location



Figure 31 – Secure the waist restraint

8. Push down on the seat while you pull the waist restraint with your other hand to tighten.
9. Attach one restraint strap (6500-001-404) to the foot end extension tube (Figure 32).

Note - The foot end extension tube must be in the mid or extended position. See *Extending or retracting the retractable foot section* (page 36).



Figure 32 – Attach to the foot end extension tube

10. Pull the restraint strap (6500-001-404) through the foot end of the child restraint (Figure 33).
11. Push down on the seat while you pull the restraint with your other hand to tighten.
12. Hold the tension while you close the rear facing lock-off on the buckle side (Figure 34).



Figure 33 – Restraint location



Figure 34 – Rear facing lock-off

13. Close the rear facing lock-off on the opposite side.
14. Place the baby into the child restraint and secure per the manufacturer's instructions.

Hanging equipment from the equipment hook

Use the equipment hook to hang additional accessories or equipment, such as defibrillators and monitors.

CAUTION

- Do not load the equipment hook above the safe working load of 35 lb (15.8 kg).
 - Always remove all accessories or equipment from the equipment hook when in the vehicle.
-

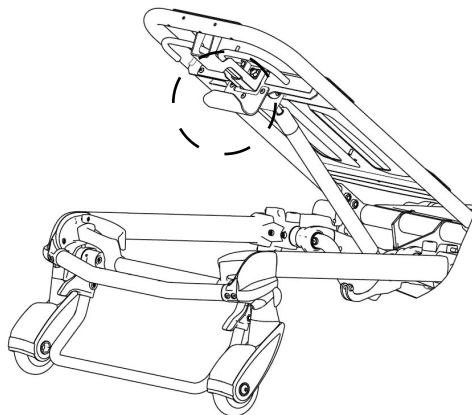

Figure 35 – Equipment hook

Positioning the two-stage IV pole option

CAUTION - Do not load the IV pole above the safe working load of 25 lb (11.3 kg).

To position the IV pole (Figure 36):

1. Lift and pivot the IV pole from the storage position. Push down until the IV pole locks into the receptacle (A).
2. To raise the height of the IV pole, turn the locking collar (B) counterclockwise and pull up on the telescoping section (C). Raise the IV pole to the desired height.
3. Turn the locking collar (B) clockwise to lock the telescoping section in place.
4. Hang the IV bags on the IV hook (D).
5. Turn the locking collar (B) counterclockwise and slide the telescoping section (C) into the bottom tube.
6. Turn the locking collar (B) clockwise to tighten.
7. Lift up and pivot the pole down into the storage position.

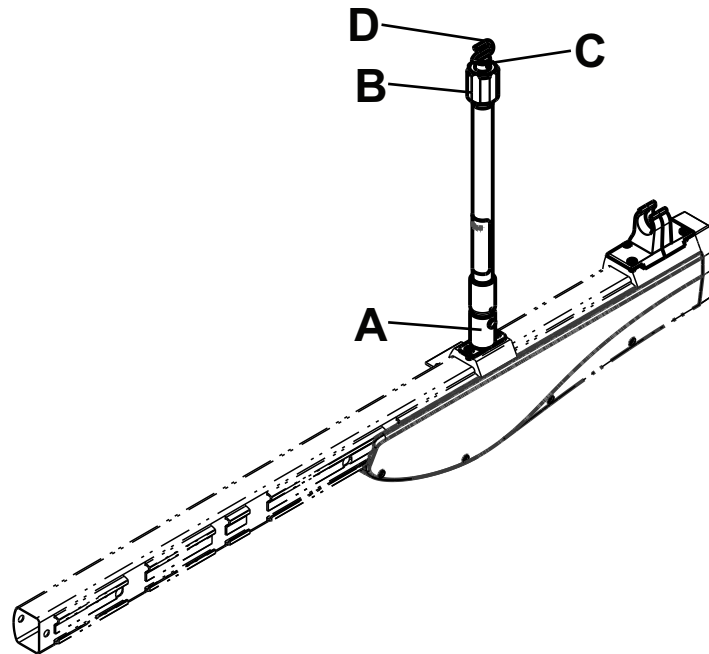

Figure 36 – Two-stage IV pole

Positioning the three-stage IV pole option

CAUTION - Do not load the IV pole above the safe working load of 25 lb (11.3 kg).

To position the IV pole (Figure 37):

1. Lift and pivot the IV pole from the storage position. Push down until the IV pole locks into the receptacle (A).
2. To raise the height of the IV pole, turn the locking collar (B) counterclockwise and pull up on the telescoping section (C). Raise the IV pole to the desired height.
3. Turn the locking collar (B) clockwise to lock the telescoping section in place.
4. For a higher IV pole, pull up on section (D) until the spring clip (E) connects.
5. Hang the IV bags on the IV hook (F).
6. To lower the IV pole, push in on the spring clip (E) and slide section (D) down into section (C). Turn the locking collar (B) counterclockwise and slide section (C) into the bottom tube.
7. Turn the locking collar (B) clockwise to tighten.
8. Lift up and pivot the pole down into the storage position.

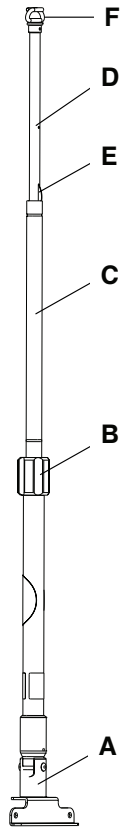

Figure 37 – IV pole raised position

Attaching an oxygen bottle to the oxygen bottle holder option

CAUTION

- Do not load the oxygen bottle holder above the safe working load of 15 lb (6.8 kg).
 - Do not use two oxygen bottle holders at the same time.
-

To attach an oxygen bottle to the oxygen bottle holder:

1. Place an oxygen bottle in the holder.
2. Insert the lower strap through the buckle and affix the strap onto itself to secure the oxygen bottle to the holder.

Note

- Do not use the oxygen bottle holder to hold an oxygen bottle holder when the transport vehicle is in motion. Always place the oxygen bottle holder in an appropriate storage location when the transport vehicle is in motion.
- Inspect the straps and clips for wear between use. Replace if the strap no longer secures the oxygen bottle.

Attaching the base storage net option

CAUTION

- Do not load the base storage net above the safe working load of 20 lb (9 kg).
 - Always be careful when you retract the base to avoid damaging items that are stored in the base storage net.
-

To attach the base storage net, wrap the **Velcro®** straps around the base tubes.

Attaching the backrest storage pouch option

CAUTION

- Do not load the single-sided backrest storage pouch above the safe working load of 10 lb (4.5 kg).
 - Do not load the dual-sided backrest storage pouch above the safe working load of 20 lb (9 kg).
 - Do not allow the storage pouch to interfere with the operation of the retractable head section.
-

To attach the single-sided or dual-sided backrest storage pouch:

1. Insert each strap through an opening in the backrest skin.
2. Mount the pouch flat against the backrest.
3. Secure the backrest storage pouch to the cot with the **Velcro®** straps.

Note - Only secure the **Velcro®** straps that correspond to the selected attachment side of the cot. Secure the **Velcro®** straps that are not in use to themselves.

Attaching the head end storage flat option

WARNING - Do not allow the head end storage flat to interfere with the operation of the retractable head section, safety bar, or vehicle safety hook.

CAUTION - Do not load the head end storage flat above the safe working load of 40 lb (18 kg).

To attach the head end storage flat (Figure 38):

1. Attach the **Velcro®** straps (A) near the pneumatic cylinder and around the cross tube (C) of the retractable head section.
2. Buckle the restraint straps (B) around the outer rails of the retractable head section.

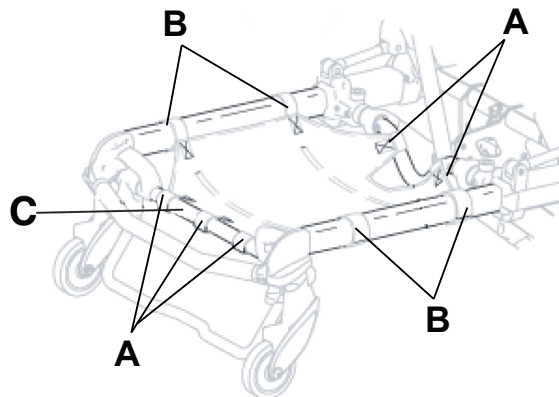

Figure 38 – Head end storage flat

Attaching the mattress

WARNING

- Always secure the mattress to the product to avoid movement during patient transfer.
 - Do not store items under the mattress. Items under the mattress may interfere with product operation.
-

The following mattress options are compatible with this product:

- Mattress, knee Gatch bolster, grey (6506-002-150) and mattress, knee Gatch bolster (6500-002-150) - use with the standard siderail

- Mattress, knee Gatch bolster, XPS, grey (6506-003-130) and Mattress, knee Gatch bolster, XPS (6500-003-130) - use with the expandable patient surface (XPS) option

To attach the mattress to the cot:

1. Align the **Velcro®** on the back of the mattress with the **Velcro®** on the cot litter.
2. Attach the strap at the foot end of the mattress through the two holes in the foot end skin on the cot litter.
3. Pull the strap through the buckle and attach the **Velcro®** to secure the strap.

Note - The mattress is a Type BF applied part.

Inserting the battery

To maximize available battery power, only use batteries that have been charged within the last 48 hours.

To insert the battery:

1. Align the tabs in the battery enclosure.
2. Push the battery into the enclosure until the latch clicks into place.

Removing the battery from the product

After you discharge the battery, remove it from the product and replace it with a charged battery.

WARNING

- Do not remove the battery when the product is active.
- Do not attempt to open the battery pack for any reason, to avoid the risk of electric shock. If the battery pack case is cracked or damaged, do not insert it into the charger. Return damaged battery packs to a service center for recycling.
- Always avoid direct contact with a wet battery or battery enclosures. Contact may cause injury to the patient or operator.

CAUTION - Always remove the battery if you do not intend to use the product for more than 24 hours or longer.

Running the battery repeatedly, without rest periods, can increase the temperature within the cells and reduce life. For example, lifting a heavy patient up and down several times in rapid succession can reduce the battery life.

To remove the battery from the product:

1. Press the battery release button (A) to release the battery from the product (Figure 39).
2. Slide the released battery out of the enclosure.

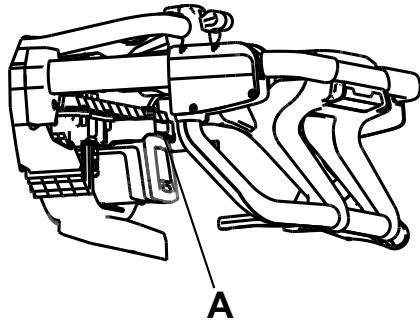

Figure 39 – Battery release button

Storing the battery

For the longevity, performance, and safety of this product, use the original packaging materials to store or transport this product.

All batteries lose charge during storage or periods of inactivity. The battery can lose up to 30 percent of its charge within 48 hours after you remove it from the charger. Use and fully charge stored batteries every three months to maintain top performance.

Charging the battery

WARNING

- Do not insert a cracked or damaged battery into the charger. Return damaged batteries to a service center for recycling.
 - Do not connect AC and DC power supplies to the battery at the same time to avoid the risk of fire or electric shock.
-

Note - For extended storage, store the battery on the charger to trickle charge. The charger keeps the battery charged and ready for use.

To charge the battery:

1. Insert a clean, dry battery into the charger. Check that the battery is locked into the charger.

Note

- When the battery is charged and ready for use, the battery power indicator will show four LEDs.
 - The maximum charge time is 4 hours.
2. Press the battery release button (A) and slide the charged battery out of the charger (Figure 40).

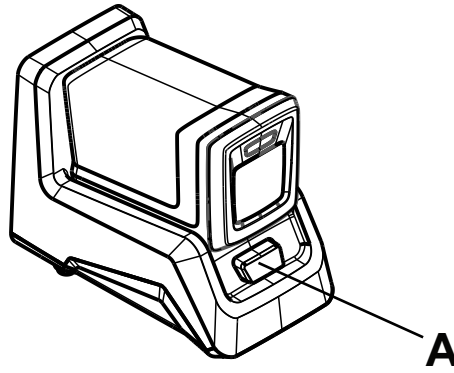

Figure 40 – Charging the battery

Electrical power requirements

For reliable and effective operation, reference the following electrical power requirements when you configure the electrical power source for the charger.

Power type	Operational voltage range	Frequency	Maximum current draw	Standby current draw	Low voltage shut off
AC	100-240 VAC, 50/60 Hz, 1A	50/60 Hz	< 1.2A	< 50 mA	90 VAC
DC	12-34 VDC, 5A	Not applicable	< 6.67A	< 150 mA	10 VDC

Charger setup

During setup, place the charger in an environmentally controlled location that is:

- Free of dust and moisture
- Kept within a constant temperature range: see *Specifications - Alvarium* (page 13)
- Readily accessible for use

Locate and maintain the power supply and power cords to minimize the risk of damage and inadvertent disconnections.

Securing the charger mounting plate option

WARNING

- Always have a certified mechanic, familiar with ambulance vehicle construction, secure the charger mounting plate option and charger.
 - Always make sure that the charger mounting plate option is secured to the surface before use.
-

To secure the charger mounting plate to a surface (Figure 41):

1. Use the charger mounting plate as a template to mark the location of the mounting holes (A).
2. Position the charger mounting plate and check that the:
 - a. Spring tab (B) is located at the rear of the charger.

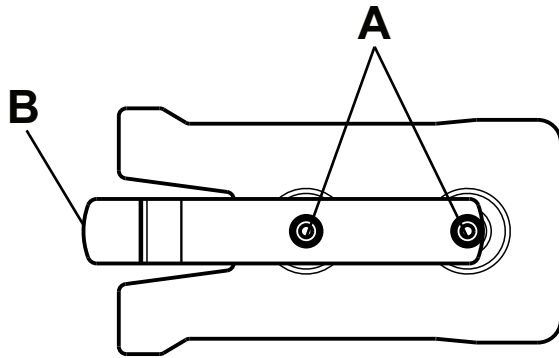

Figure 41 – Charger mounting plate

- b. Power cord easily plugs into the rear of the charger.
- c. Charger slides from front to back to connect to the plate after mounting.
- d. Charger mounting plate is secured for the ambulance or station location:

Ambulance location (AC or DC power)	Station location (AC power)
<ul style="list-style-type: none"> • Secure the plate to a horizontal surface or shelf with size #10, grade 5 flat head screws minimum (not supplied) • For vertical securement, position the mounting plate with the spring tab below the mounting screws, so the charger supports the battery if you press the battery release button • Check that the selected mounting surface is strong enough to support the charger and battery during transport • Allow for easy battery insertion and removal • Locate the power supply within reach of the power cord 	<ul style="list-style-type: none"> • Secure the plate to a horizontal or vertical surface with size #10, grade 5 flat head screws minimum (not supplied) • For vertical securement, position the mounting plate with the spring tab below the mounting screws, so the charger supports the battery if you press the battery release button • Allow for easy battery insertion and removal

Securing the charger to the charger mounting plate option

To secure the charger to the charger mounting plate (Figure 42):

1. Move the red AC/DC slider (A) to the center position. Avoid interference between the hook features and charger mount spring.
2. Align the rear keyway slots (B) onto the charger mounting plate fasteners (C).
3. Slide the charger (D) onto the charger mounting plate (E) until locked.

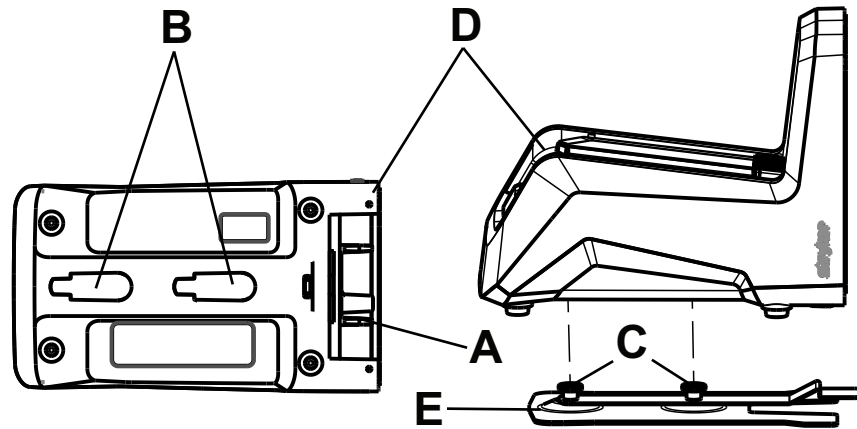

Figure 42 – Securing the charger to the charger mounting plate

Powering the charger

CAUTION

- Always place the electrical charger power cord where it will not be stepped on, tripped over, or otherwise subjected to damage or stress.
- Do not touch the battery receptacle terminals with metal objects.

To power the charger (Figure 43):

1. Locate the power connection on the back of the charger.
2. Move the red AC/DC slider to expose the port and select the desired voltage configuration (AC or DC).

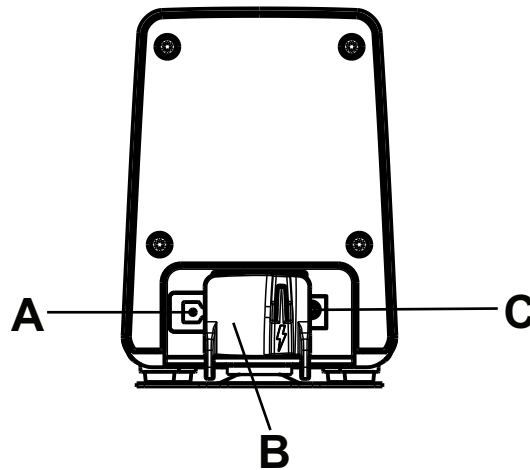

Figure 43 – Charger rear view

A	AC input
B	Red AC/DC slider
C	DC input

3. Insert the power cord into the exposed charger port.
4. Insert the other end of the charger power cord into a clean, uninterruptible power source.

Note - Use only Stryker approved parts to power the charger.

Disconnecting the charger

CAUTION - Always grasp and pull the plug, not the cord, when you disconnect the charger to avoid the risk of damage to the electrical plug and cord.

To disconnect the charger, unplug the power cord from the AC or DC power source.

Accessories and parts

These accessories may be available for use with your product. Confirm availability for your configuration or region. Call Stryker Customer Service: 1-800-327-0770.

Name	Number
Belt extension	6082-160-050
Charger mounting plate	650700450031
HAVASU™ IV pole, two-stage, left	650700350005
HAVASU IV pole, two-stage, right	650700350001
HAVASU IV pole, three-stage, left	650700350006
HAVASU IV pole, three-stage, right	650700350002
Kit, MTS sensor assembly	650707000001
Mattress, knee Gatch bolster	6500-002-150
Mattress, knee Gatch bolster, grey	6506-002-150
Mattress, knee Gatch bolster, XPS	6500-003-130
Mattress, knee Gatch bolster, XPS, grey	6506-003-130
Oxygen bottle holder, Fowler	650700450053
Oxygen bottle holder, head section	650700450054
Restraint package, XPR	650600030010
Restraint package, X-restraint	6500-001-430
Restraint package, X-restraint, blue	6500-001-431
Siderail, standard	650709990002
Siderail, XPS option	650709990001
Storage flat, head end	6500-128-000
Storage net, base	6500-160-000
Storage pouch, backrest, dual-sided	650700450134
Storage pouch, backrest, single-sided	650700450142
Wheel lock option, two	650709990009
Wheel lock option, four	650709990010

Use only Stryker-approved parts. Other parts may result in increased electromagnetic emissions or decreased electromagnetic immunity of the system. Do not modify parts. Failure to comply may result in injury.

Name	Number
Power components - AC	
Battery	650700080301
Battery (2x)	650700080302

Name	Number
Charger	650700450301
Power cord, Argentina	650700450212
Power cord, Australia	650700450105
Power cord, Brazil	650700450109
Power cord, China	650700450108
Power cord, Europe	650700450103
Power cord, Israel	650700450210
Power cord, Japan	650700450106
Power cord, North America	650700450102
Power cord, South Africa	650700450211
Power cord, South Korea	650700450213
Power cord, Switzerland	650700450107
Power cord, United Kingdom	650700450104
Power components - DC	
12 VDC cable, automotive	650700450101

Preventive maintenance

WARNING - Do not use bare hands to check for hydraulic leaks.

CAUTION - Always use authorized parts to avoid the risk of product damage.

Establish and follow a maintenance schedule and keep records of the maintenance activity. Remove product from service before you perform the preventive maintenance inspection. You may need to perform preventive maintenance checks more often based on your level of product usage. Service only by qualified personnel.

When using maintenance products, follow the directions of the manufacturer and reference all Material Safety Data Sheets (MSDS).

Lubrication

CAUTION - Do not lubricate the bearings in the X-frame as it will degrade the performance of the cot and may void its warranty.

The cot has been designed to operate without the need for lubrication.

Regular inspection and adjustments

The following schedule is a general guide to maintenance. Factors such as weather, terrain, geographical location, and individual usage will alter the required maintenance schedule. If you are unsure how to perform these checks, contact your Stryker service technician. If you are in doubt as to what intervals to follow to maintain your product, consult your Stryker service technician. Check each routine and replace worn parts if necessary.

Every month or two hours

Inspect these items every month or two hours of motor run time, whichever comes first.

Item	Inspect
Settings	In-fastener shutoff configuration
Cylinder	Extend cylinder rod and wipe with a soft cloth and household cleaner
Cables and wires	No hanging wires from routings or connections
	Hand tighten foot end electronics cable
Manual back-up release handle	Manual back-up release handle functions
Litter	Frame and litter
Base	Frame and base
Wheels	All wheels are secure, roll, and swivel
Head section	Pull toward the head section to check that the safety bar swings and rotates and pulls back to the home position
Foot section	Extend and retract
	Functions and latches
Restraint	Function with no excessive wear (such as a bent or broken receiver or latch plate or torn or frayed webbing)

Item	Inspect
Battery	Housing and terminal area for cracks or damage before first and every use
Charger	For cuts in the cord, bent pins or contacts, or cracks in the housing before first and every use

Every three months or six hours

Inspect these items every three months or six hours of motor run time, whichever comes first.

Item	Inspect
Hydraulics	Motor mount fasteners are secure
	No hydraulic fluid leaks
	No leaks from reservoir
Cables and wires	No damage or pinching of wiring harness, cable, or lines
	No damaged connectors
Manual back-up release handle	Base extends and retracts when you pull the manual back-up release handle
Litter	All fasteners are secure
	Backrest cylinder operates
	Adjust pneumatic cylinder for full range of motion, if required
Base	All fasteners are secure
X-frame	X-frame expands and retracts
Head section	All fasteners are secure
	Head section extends and locks
Foot section	Transport handle extends and locks in 90 degree upright position
	All fasteners are secure
	Foot section extends and locks in the retracted, mid, and extended positions
	Stow and lock transport handle
	Foot end guide lights operate
Accessories and parts	All accessories and parts operate

Every six months or 12 hours

Inspect these items every six months or 12 hours of motor run time, whichever comes first.

Item	Inspect
Electronic controls/functions	Extend cot to raised position, measure and check load height

Item	Inspect
	Jog function operates
	High speed retract and extend operates
	Bumper detection operates
	Press the release or transport height button and confirm correct height
	Measure load height and confirm correct height
Switches	No damage or wear to the switches
	All switches operate
Litter	No bent, broken, or damaged components
	No damage or tears on cot grips
	Siderails operate and latch
	Footrest operates
Mattress	No cracks or tears
Base	No bent, broken, or damaged components
	Cot retaining post is secure. If not, replace the screw.
	No excessive damage to X-frame guards
Wheels	Free of debris
	Steer-Lock and wheel locks operate
	Check brake cable (between Steer-Lock and wheel lock) for wear, bends, creases
Head section	No bent, broken, or damaged components
	Grip bar has no excessive damage or tears
	Load wheels are secure and roll
Foot section	No bent, broken, or damaged components
	Grip bar has no excessive damage or tears

Every 12 months or 24 hours

Inspect these items every 12 months or 24 hours of motor run time, whichever comes first.

Item	Inspect
Settings	Cot and fastener fit and function
	Safety bar connects to the vehicle safety hook
Manual back-up release handle	Returns to the stowed position
Litter	All welds are intact, not cracked, or broken
	Warning labels present and legible

Item	Inspect
Base	All welds are intact, not cracked, or broken
Retractable head section oxygen bottle holder option	Straps and clips for wear
Foot section	Foot end hitch latch hooks not worn
Cables and wires	Foot end interface board (FEIB) cable connector is tight
Transport handle	Apply Tri-Flow™ lubricant (6082-199-012) to the transport handle internal joints

Cleaning and disinfecting with SideKick®

For United States only. Confirm availability for your configuration or region. Call Stryker Customer Service: 1-800-327-0770.

Stryker's preferred spray (2070-000-001) and 6" x 10" wipes (2060-000-001) include the following active ingredients:

- n-Alkyl (60% C14, 30% C16, 5% C12, 5% C18) dimethyl benzyl ammonium chloride - 0.154%
- n-Alkyl (68% C12, 32% C14) dimethyl ethylbenzyl ammonium chloride - 0.154%
- Isopropanol - 21.000%

Non-active ingredient: Ethylene Glycol Monobutyl Ether – < 3%

Note - For safety information, read the product label.

To clean or disinfect the external product surface with SideKick wipe:

To clean:

1. Wipe down the external product surface with a fresh, clean wipe to remove all visible soils.
2. Repeat as necessary until the external product surface is visibly clean.
3. Wipe dry with a cloth or allow the external product surface to air dry before you return the product to service.

Note - Use as many wipes as necessary.

To disinfect:

1. Clean first.
2. Wipe down the external product surface with a fresh, clean wipe until wet.
3. Allow the external product surface to remain wet for two minutes at room temperature.
4. Wipe dry with a cloth or allow the external product surface to air dry before you return the product to service.

To clean or disinfect the external product surface with SideKick spray:

To clean:

1. Spray **SideKick** on a mop, sponge, paper cloth, or cloth towel.
2. Wipe down the external product surface with a fresh, clean mop, sponge, paper cloth, or cloth towel to remove all visible soils.
3. Repeat as necessary until the external product surface is visibly clean.
4. Wipe dry with a cloth or allow the external product surface to air dry before you return the product to service.

To disinfect:

1. Clean first.
2. Spray **SideKick** on a mop, sponge, paper cloth, or cloth towel.
3. Wipe down the external product surface with a fresh, clean mop, sponge, paper cloth, or cloth towel until wet.
4. Allow the external product surface to remain wet for two minutes at room temperature.
5. Wipe dry with a cloth or allow the external product surface to air dry before you return the product to service.

Note - Follow your hospital protocols to launder cloth towels or dispose of wipes or paper cloths.

Cleaning and disinfecting the XPR restraint straps

Confirm availability for your configuration or region. Call Stryker Customer Service: 1-800-327-0770.

Suggested cleaners include:

- ≤ 70% isopropyl alcohol; or

A cleaner with the following active ingredients (or equivalent):

- Ammonium salts ≤ 0.31%
- Isopropyl alcohol ≤ 21.000%
- Ethylene glycol monobutyl ether ≤ 3.000% (non-active ingredient)

Note - Failure to use the prescribed cleaners may cause premature degradation and void the product's warranty. For example, do not clean with bleach, **HDQ Neutral®**, or accelerated hydrogen peroxide. If you have questions or concerns, please reach out to Stryker Customer Service (1-800-327-0770).

Recommended cleaning method:

1. Follow the cleaning solution manufacturer's dilution recommendations exactly.
2. To clean, wipe external surfaces to remove all visible soils. Repeat as necessary until the product is clean.

Note - Move the extension buckle to clean the entire restraint strap. Make sure that the restraint surface is dry before you move the extension buckle. Do not move the extension buckle over a surface that is wet with cleaner.

3. To disinfect, wipe external surfaces until wet.
4. Make sure that the product does not stay wet longer than the chemical manufacturer's guidelines for proper disinfecting.
5. Check functionality before you return the product to service.
 - Immersing restraint strap metal buckles can cause buckle corrosion and is not recommended. Rinse with clean water and allow to air dry to reduce chance of corrosion. Replace restraints if metal buckles are corroded.
 - Direct skin contact with visibly soiled, permeable material may increase the risk of infection.
 - Laundering the restraint straps is not recommended.

CAUTION - Do not apply lubricants to the surfaces of the restraints.

Note

- XPR restraint straps have a three month expected service life when using the suggested cleaners shown above.
- Failure to follow the above directions when using these types of cleaners may void this product's warranty.
- Always wipe the product with clean water and dry after cleaning. Some cleaning products are corrosive in nature and may cause damage to the product. Failure to properly rinse and dry the product leaves a corrosive residue on the surface of the product and may cause premature degradation of critical components.

Cleaning the product

WARNING

- Always follow these cleaning and disinfecting guidelines, in addition to your protocols, to maintain hygienic safety.
 - Always use any appropriate personal protective equipment while power washing to avoid inhaling contagion. Power washing equipment may aerate contamination.
-

CAUTION

- Always remove the battery before you wash the product.
 - Do not clean, service, or perform maintenance while the product is in use.
 - Do not steam clean or ultrasonically clean the product.
 - Do not exceed 180 °F (82 °C) as the maximum water temperature.
 - Do not exceed 1500 psi (103.4 bar) as the maximum water pressure. If you are using a hand held wand to wash the product, keep the pressure nozzle at a minimum of 24 in. (61 cm) from the product.
-

The product is power washable. The product may show some signs of oxidation or discoloration from continuous washing. No degradation of the product's performance will occur from power washing as long as you follow the proper procedures.

- Immersing restraint strap metal buckles can cause buckle corrosion and is not recommended. Rinse with clean water and allow to air dry to reduce chance of corrosion. Replace restraints if metal buckles are corroded.
- Direct skin contact with visibly soiled, permeable material may increase the risk of infection.

Recommended cleaning method:

1. Remove the mattress and battery from the product.
2. Follow the disinfectant solution manufacturer's dilution recommendations exactly.
3. Stryker recommends the standard hospital cart washer for power washing.
4. Allow the product to air dry.
5. Check functionality before you return the product to service.

Disinfecting the product

In general, when used in concentrations recommended by the manufacturer, either phenolic type or quaternary (excluding **Virex**® TB) type disinfectants can be used. Iodophor type disinfectants are not recommended for use because staining may occur.

Recommended disinfectants:

- Quaternary cleaners (active ingredient - ammonium chloride) that contain less than 3% glycol ether
- Phenolic cleaners (active ingredient - o-phenylphenol)
- Chlorinated bleach solution (5.25% - less than 1 part bleach to 100 parts water)
- ≤ 21% isopropanol alcohol

Recommended disinfection method:

1. Follow the disinfectant solution manufacturer's dilution recommendations exactly.
2. Hand wash all surfaces of the product with a disinfectant solution.
3. Avoid oversaturation and make sure that the product does not stay wet longer than the chemical manufacturer's guidelines for proper disinfecting.
4. Allow the product to air dry.
5. Disinfect the **Velcro**® after every use. Saturate the **Velcro**® with disinfectant, rinse with water, and allow the disinfectant to evaporate. Appropriate disinfectant for nylon **Velcro**® should be determined by the service.
6. Check functionality before you return the product to service.

Note

- Failure to follow the above directions when using these types of disinfectants may void this product's warranty.
- Always wipe the product with clean water and dry after cleaning. Some cleaning agents are corrosive in nature and may cause damage to the product. Failure to properly rinse and dry the product leaves a corrosive residue on the surface of the product and may cause premature corrosion of critical components.

Cleaning the charger

WARNING

- Always wear rubber gloves, in addition to personal protective equipment, when cleaning the battery to reduce the risk of injury.
 - Always disconnect the charger from the wall outlet before cleaning to avoid the risk of electrical hazards.
 - Do not spray fluid directly onto the charger.
 - Do not power wash the charger.
 - Do not use solvents, lubricants, or other chemicals to clean the charger unless otherwise directed.
 - Do not immerse the charger in liquid or allow liquid to collect on top of the charger to avoid the risk of electric shock.
-

To clean the charger:

1. Disconnect the charger from the wall outlet to avoid electrical hazards during cleaning.
2. Wipe surfaces of the charger with a soft cloth dampened with a non-abrasive, disinfectant solution. See *Disinfecting the product*.
3. Wipe with a cloth moistened with clean water to remove any cleaning chemicals or residue.
4. Dry before you return the charger to service.

Cleaning the battery

WARNING

- Always wear rubber gloves, in addition to personal protective equipment, when cleaning the battery to reduce the risk of injury.
 - Always use only non-conductive materials to wipe the battery.
 - Always avoid excessive water exposure to the battery terminals.
 - Do not directly handle or make contact with the battery terminals while cleaning to avoid the risk of injury.
 - Do not immerse the battery in liquid or allow liquid to collect on top of the battery to avoid the risk of electric shock.
 - Do not use solvents, lubricants, or other chemicals to clean the battery unless otherwise directed.
 - Do not power wash the battery.
-

CAUTION - Do not steam clean or ultrasonically clean the product.

To clean the battery:

1. Remove the battery from the product or charger.
2. Inspect the battery housing and terminal area for any cracks or damage.
3. Clean the battery with a disinfectant solution. See *Disinfecting the product*.
4. Rinse the battery with clean water to remove any cleaning chemical or residue. Position the battery to avoid water from pooling near the terminals.
5. Dry before you insert the battery into the product or charger.

Wireless notifications

For product equipped with optional wireless communication technology, these statements apply to the countries as indicated:

Country	Notification
Canada	<p>Contains IC: 4919E-SDMACP</p> <p>Contains IC: 4919E-6507</p> <p>This device complies with Innovation, Science and Economic Development Canada's license-exempt RSSs. Operation is subject to the following two conditions: (1) this device may not cause interference, and (2) this device must accept any interference, including interference that may cause undesired operation of the device.</p> <p>Le présent appareil est conforme aux CNR d'Industrie Canada applicables aux appareils radio exempts de licence. L'exploitation est autorisée aux deux conditions suivantes : (1) l'appareil ne doit pas produire de brouillage, et (2) l'utilisateur de l'appareil doit accepter tout brouillage radioélectrique subi, même si le brouillage est susceptible d'en compromettre le fonctionnement.</p>
Israel	<p>מספר אישור אלחוטי של משרד התקשורת הוא 55-13143 אסור להחליף את האנטנה המקורית של המכשיר ולא לעשות בו כל שינוי טכני אחר</p>
Mexico	<p>La operación de este equipo está sujeta a las siguientes dos condiciones: (1) es posible que este equipo o dispositivo no cause interferencia perjudicial y (2) este equipo o dispositivo debe aceptar cualquier interferencia, incluyendo la que pueda causar su operación no deseada.</p>
Singapore	<div style="border: 1px solid black; padding: 5px; width: fit-content;"> <p>Complies with IMDA Standards DA103640</p> </div>
South Africa	<div style="border: 1px solid black; padding: 10px; width: fit-content;">  <p>TA-2022/0845 APPROVED</p> </div>
United States	<p>Contains FCC ID: Z7A-SDMACP</p> <p>Contains FCC ID: Z7A-6507</p> <p>This device complies with Part 15 of the FCC Rules. Operation is subject to the following two conditions: (1) this device may not cause harmful interference, and (2) this device must accept any interference received, including interference that may cause undesired operation.</p> <p>Changes or modifications not expressly approved by the party responsible for compliance could void the user's authority to operate the equipment.</p> <p>Frequency Tolerance: +/-20 ppm</p>

Wireless coexistence notifications

Microwaves are regulated by the federal government through 21 CFR §1030.10 such that the amount of power that can leak from a microwave oven over its lifetime is very small, such as 5mW/cmsq @ 2" from the plane of the microwave

surface. This radiation will roll off rapidly as the distance between the microwave and the measurement point increases. Other radiation in this band can be generated from unintentional radiators and from the control and source circuitry in the microwave. The level of this radiation is also controlled via federal regulations from the FCC and is not of a high magnitude. These two sources of noise are both contained inside the microwave oven which is shielded and designed to minimize this radiation. In general, the user of the medical device will not be in close proximity to the microwave oven when using the medical device.

EMC information

WARNING

- Portable RF communications equipment, including peripherals such as antenna cables and external antennas, should be used no closer than 12 inches (30 cm) to any part of **Power-PRO 2**, including cables specified by the manufacturer.
- Avoid stacking or placing other equipment adjacent to **Power-PRO 2** to prevent improper operation of the products. If such use is necessary, carefully observe the cot and the other equipment to verify proper operation.
- The use of accessories, transducers, and cables, other than those specified or provided by the manufacturer, could result in increased electromagnetic emissions or decreased electromagnetic immunity and result in improper operation.

Guidance and manufacturer's declaration - electromagnetic emissions		
Emissions test	Compliance	Electromagnetic environment
Power-PRO 2 is intended for use in the electromagnetic environment specified below. The customer or the user of Power-PRO 2 should assure that they are used in such an environment.		
RF emissions CISPR 11	Group 2	Power-PRO 2 with the Power-LOAD compatibility option must emit electromagnetic energy in order to perform its intended function. Nearby electronic equipment may be affected.
RF emissions CISPR 11	Group 1	The emissions characteristics of this equipment make it suitable for use in professional healthcare facilities, emergency medical services, and home healthcare environments. If it is used in other environments, this equipment might not offer adequate protection to radio-frequency communication services and power supply networks. The user might need to take mitigation measures, such as relocating or reorienting the equipment.
RF emissions CISPR 11	Class B	

Guidance and manufacturer's declaration - electromagnetic immunity			
Immunity test	IEC 60601 test level	Compliance level	Electromagnetic environment-guidance
Electrostatic discharge (ESD) IEC 61000-4-2	± 8 kV contact ± 15 kV air	± 8 kV contact ± 15 kV air	Floors should be wood, concrete or ceramic tile. If floors are covered with synthetic material, the relative humidity should be at least 30%.
Power frequency (50/60 Hz) magnetic field IEC 61000-4-8	30 A/m	30 A/m	Power frequency magnetic fields should be at levels characteristic of a typical location in a typical commercial or hospital environment.

Guidance and manufacturer's declaration - electromagnetic immunity

<p align="center">Radiated RF IEC 61000-4-3</p>	<p align="center">10 V/m 80 MHz to 2.7 GHz</p>	<p align="center">10 V/m</p>	<p>Portable and mobile RF communications equipment should follow the guidance in the table titled Recommended separation distances between portable and mobile RF communication equipment and Power-PRO 2. If the mobile service is not listed in the table, the recommended separation distance should be calculated from the equation appropriate for the frequency of the transmitter.</p> <p>Recommended separation distance:</p> $D=(0.6) (\sqrt{P})$ <p>where <i>P</i> is the maximum output power rating of the transmitter in watts (W) according to the transmitter manufacturer and <i>d</i> is the recommended separation distance in meters (m).</p> <p>Field strengths from fixed RF transmitters, as determined by an electromagnetic site survey^a should be less than the compliance level in each frequency range.^b</p> <p>Interference may occur in the vicinity of equipment marked with the following symbol:</p> 
---	--	------------------------------	---

Note - These guidelines may not apply in all situations. Electromagnetic propagation is affected by absorption and reflection from structures, objects, and people.

^a Field strengths from fixed transmitters, such as base stations for radio (cellular/cordless) telephones and land mobile radios, amateur radio, AM and FM radio broadcast, and TV broadcast cannot be predicted theoretically with accuracy. To assess the electromagnetic environment due to fixed RF transmitters, an electromagnetic site survey should be considered. If the measured field strength in the location in which **Power-PRO 2** is used exceeds the applicable RF compliance level above, the **Power-PRO 2** system should be observed to verify normal operation. If abnormal performance is observed, additional measures may be necessary, such as reorienting or relocating **Power-PRO 2**.

^b Over the frequency range 150 kHz to 80 MHz, field strengths are less than 10 V/m.

Recommended separation distances between portable and mobile RF communications equipment and Power-PRO 2			
Band (MHz)	Service	Maximum power (W)	Minimum separation distance (m)
<p>Power-PRO 2 is intended for use in an electromagnetic environment in which radiated RF disturbances are controlled. The customer or the user of Power-PRO 2 can help prevent electromagnetic interferences by maintaining a minimum distance between portable and mobile RF communications equipment (transmitters), Power-PRO 2, and cables, as recommended below, according to the maximum output power of the communications equipment.</p>			
380-390	TETRA 400	1.8	0.3
430-470	GMRS 460 FRS 460	2.0	0.3
704-787	LTE band 13, 17	0.2	0.3
800-960	GSM 800/900 TETRA 800 iDEN 820 CDMA 850 LTE band 5	2.0	0.3
1,700-1,990	GSM 1800 CDMA 1900 GSM 1900 DECT LTE band 1, 3, 4, 25 UMTS	2.0	0.3
2,400-2,570	Bluetooth WLAN 802.11 b/g/n RFID 2450 LTE band 7	2.0	0.3
5,100-5,800	WLAN 802.11 a/n	0.2	0.3
<p>For transmitters rated at a maximum output power not listed above, the recommended separation distance d in meters (m) can be estimated using the equation applicable to the frequency of the transmitter, where P is the maximum output power rating of the transmitter in watts (W) according to the transmitter manufacturer.</p> <p>Note: These guidelines may not apply in all situations. Electromagnetic propagation is affected by absorption and reflection from structures, objects, and people.</p>			

CAUTION - Changes or modifications to the **Alvarium** Battery Management System, not expressly approved by Stryker, could void the user's authority to operate the equipment.

For United States only:

Alvarium Battery Management System: Model 650700080301 (battery) and Model 650700450301 (charger)

Note - This equipment has been tested and found to comply with the limits for a Class B digital device, pursuant to part 15 of the FCC Rules. These limits are designed to provide reasonable protection against harmful interference in a residential installation. This equipment generates, uses and can radiate radio frequency energy and, if not installed and used in accordance with the instructions, may cause harmful interference to radio communications. However, there is no guarantee that interference will not occur in a particular installation. If this equipment does cause harmful interference to radio or television reception, which can be determined by turning the equipment off and on, the user is encouraged to try to correct the interference by one or more of the following measures:

- Reorient or relocate the receiving antenna
- Increase the separation between the equipment and receiver
- Connect the equipment into an outlet on a circuit different from that to which the receiver is connected
- Consult the dealer or an experienced radio or TV technician for help

stryker



Stryker Medical
3800 E. Centre Avenue
Portage, MI 49002
USA